

Pitco Frialator

Installation and Operation Manual

for the Gas and Electric
Rethermalizer

Model Numbers

RTG14 & 18

&

RTE14

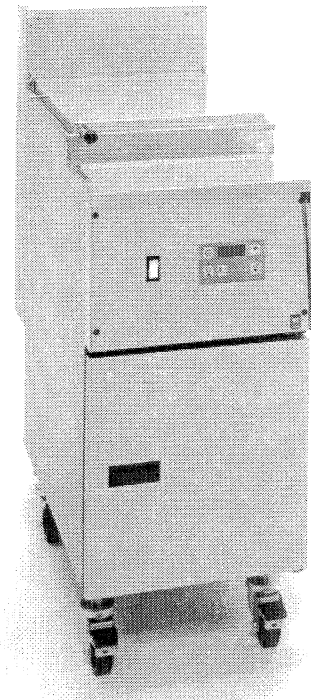
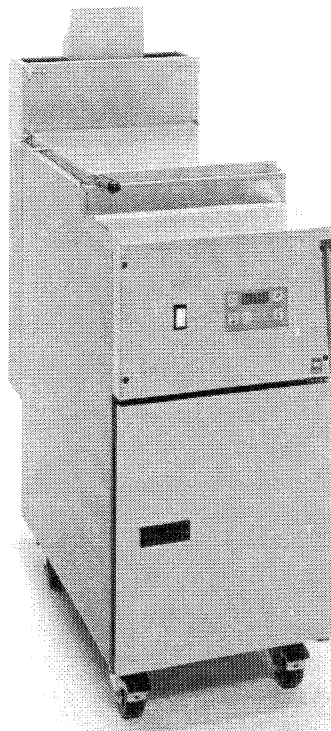

There's Always Something Cooking!



English

Français

NOTICES

There are three different types of notices that you should be familiar with, a NOTICE, CAUTION, and WARNING. A NOTICE is a special note used to call attention to a particularly important point. CAUTION is used to point out a procedure or operation which may cause equipment damage. The WARNING notice is the most important of the three because it warns of an operation that may cause personal injury. Please familiarize yourself with your new Rethermalizer before operating it and heed the notices throughout this manual. The WARNINGS are listed below and on the following page for your review prior to operating the unit.

FOR YOUR SAFETY

DO NOT store or use gasoline or other flammable vapors or liquids in the vicinity of this or any other appliance.

WARNING: Improper installation, adjustment, alteration, service or maintenance can cause property damage, injury or death. Read the installation, operating and maintenance instructions thoroughly before installing or servicing this equipment.

TO THE PURCHASER

POST IN A PROMINENT LOCATION INSTRUCTIONS TO BE FOLLOWED IN THE EVENT THAT AN OPERATOR SMELLS GAS. OBTAIN THIS INFORMATION FROM YOUR LOCAL GAS SUPPLIER.

WARNING
This appliance is equipped with a three prong (grounding) plug. This is for your protection against shock hazard in the event of equipment malfunction. Always plug the unit directly into a properly grounded three-prong receptacle. **DO NOT** cut or remove the grounding (third) prong.

WARNING
DO NOT use an open flame to check for gas leaks! Keep all open flames away from the Rethermalizer until the installation is complete.

WARNING
A Rethermalizer equipped with casters and a flexible power cord, must be connected to the gas supply with a Quick-Disconnect device. This quick disconnect must comply with ANSI Z24.41. To limit the movement of the unit without depending on the connector or quick disconnect, a restraining cable must also be installed.

WARNING
There is an open gas flame inside the Rethermalizer. The unit may get hot enough to set nearby materials on fire. Keep the area around the unit free from combustibles.

WARNING
Ensure that the Rethermalizer can get enough air to keep the flame burning correctly. If the flame is starved for air it can give off a dangerous carbon monoxide gas. Carbon Monoxide is a clear odorless gas that can cause suffocation.

WARNING
Carbon monoxide can build up if you block the flue. Blocking the flue will also cause the unit to overheat. **DO NOT** obstruct the flow of combustion/ventilation or air opening around the Rethermalizer. Ensure that you meet the minimum clearances specified in the installation instructions. Adequate clearance around the unit is necessary for servicing and proper burner operation.

WARNING
Wait 5 minutes before attempting to relight the pilot. This will allow for any gas in the unit to dissipate.

WARNING
The power supply must be disconnected before servicing or cleaning the appliance.

WARNING
The Rethermalizer must be properly restrained to prevent movement or tipping. This restraint must prevent the unit from movements that would splash hot liquids on personnel. This restraint may be by any means (alcove installation, adequate ties, or battery installation).

WARNING
DO NOT obstruct the flow of combustion/ventilation or air openings around the rethermalizer. Adequate clearance around the rethermalizer is necessary for servicing and proper burner operation. Ensure that you meet the minimum clearances specified in the installation instructions.

WARNING
NEVER supply the Rethermalizer with a gas that is not indicated on the data plate. Using the incorrect gas type will cause improper operation. If you need to convert the unit to another type of fuel, contact your dealer.

WARNING
In the event of a fire, use **ONLY** a dry chemical extinguisher. The extinguisher should be a B/C or A/B/C type extinguisher that contains sodium bicarbonate or potassium bicarbonate.

**THIS MANUAL MUST BE
RETAINED FOR FUTURE
REFERENCE**

Table of Contents

Chapter 1: General Information and Installation	1
Checking your new Rethermalizer:	1
Check Your Order	1
Chapter 2: Assembly, Leveling and Installation	2
Caster Installation and Adjustment	2
Installation	2
Installation Clearances	2
Gas Connection (On Gas machines only)	3
Plumbing Connections	3
Electrical Connection	4
Ventilation and Fire Safety Systems (Gas machines only)	4
Chapter 3: Initial Adjustments	6
Visual Checks and Equipment Locations	6
Filling the Rethermalizer	6
Pilot Light System (Gas machines with Electronic Ignition Pilot only)	6
Pilot Light System (Gas machines with Standing Pilot only)	7
Main Burner System (Gas machines only)	8
Initial Cleaning	9
High Limit Switch	10
Chapter 4: Operating Instructions	11
Filling the Rethermalizer	11
Manual Operation of the Water Fill System	11
Start-Up and Use	11
Shutdown	12
Power Failure	12
Programming the Controller	12
The Intellifry Computer	14
Chapter 5: Maintenance, Adjustments, and Service	16
Daily Cleaning	16
Weekly Cleaning	16
Flue and Baffle Inspection (Gas machines only)	17
Service	17
Schematics	18-19
RTG14 with Digital Control	18
RTE14 with Digital Control	19

Chapter 1: General Information and Installation

The Pitco Frialator Rethermalizer is a revolutionary new reheating unit. By using Pitco Frialator's Quick Heating Systems, the Rethermalizer is up to temperature and ready to cook within 30 to 45 minutes. The RTG14 cook tank holds approximately 15 gallons of water and the RTG18, approximately 30 gallons, whose level is maintained automatically by the unit. The water temperature is monitored and controlled by its own Electronic Temperature Control mounted in the front panel. Each Temperature Control is preset at the factory to maintain the water temperature at 195°F. It is fully programmable for cases of increased altitude where the cook temperature must be decreased. Quick recovery time and even temperatures are assured by using heating elements on electric machines or heating tubes on gas machines. The Rethermalizer is very easy to use, allowing you to Rethermalize and not worry about the unit. However, it is important that you familiarize yourself with the operation and safety notices of this manual. This manual contains the Installation, Operation, Maintenance and Service procedures for the Rethermalizer. Do not discard this manual, store it in a safe place for future reference.

Checking your new Rethermalizer:

Every effort has been made to ensure that your Rethermalizer will be delivered to you in perfect condition. As you unpack the Rethermalizer, inspect the unit for damage. If something is damaged, DO NOT sign the bill of lading, and save the packing materials. Contact the Freight Company immediately, because they are only responsible for 15 days after delivery. Check the packing list enclosed with your Rethermalizer to ensure that you have received everything on the list. If you are missing any parts, contact the dealer from whom the unit was purchased. As you unpack the Rethermalizer be careful to keep its weight evenly distributed.

CAUTION

To prevent equipment damage, do not tilt the unit onto any two of its legs. Do not pull on the Flue or Electric Elements

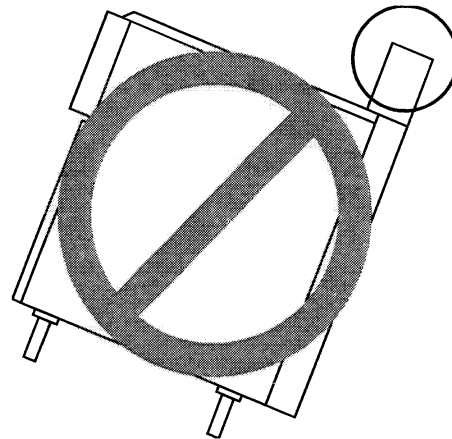

Locate your Pitco Frialator warranty and make note of the Date Received and Model and Serial Numbers, located on the Data plate mounted on the inside of the door. Put your warranty in a safe place for future reference. DO NOT return the warranty sheet to Pitco Frialator. With the exception of the Legs or Casters, the Rethermalizer has been fully assembled for you at the factory and is ready to be installed.

Check Your Order:

In the shipping crate with the Rethermalizer you will also find:

- | | | | |
|-----|-----------------------|-----|---------------------------------|
| (1) | Cleaning Brush | (1) | Tube Screen |
| (1) | Meat Racks (Optional) | (1) | Pan Support Rack Kit (Optional) |

Chapter 2: Assembly, Leveling and Installation:

When you receive your Rethermalizer it is completely assembled with the possible exception of the casters.

Caster Installation and Adjustment:

In order to install the casters on your new Rethermalizer you will need a $\frac{7}{16}$ " combination wrench and a $\frac{7}{16}$ " socket. The casters must be installed before continuing with the installation. The casters provide the necessary height to meet sanitation requirements and assure adequate air supply to the burner system on gas machines. Attach the casters by performing the following procedure.

- a. Lay the Rethermalizer on its back being careful not to damage the flue (on gas machines) by pulling on it. Protect the outside of the unit with cardboard or a drop cloth when laying it down.
- b. Attach each caster with the hex head cap nut supplied with the Rethermalizer. Each caster requires four $\frac{1}{4}$ -20 x $\frac{5}{8}$ " bolt. Mount the Locking Casters in the front of the machine.
- c. Mount the bolts from the inside of the unit with the nut on the outside of the cooker. The nuts have lock washers attached to them, therefore it is not necessary to use lock washers.
- d. When all four casters are mounted, stand the unit up being careful not to put too much weight on any one caster.
- e. Move the Rethermalizer to the desired location and lock the front wheels.

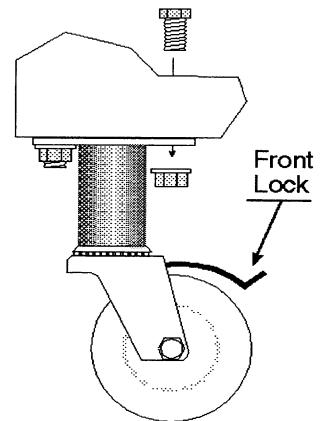

Installation:

Although it is possible for you to install and set up your new Rethermalizer, it is **STRONGLY** recommended that you have it done by qualified professionals. The professionals that install your new Rethermalizer will know the local building codes and ensure that your installation is safe. This manual provides the installer with valuable information on the installation of your Rethermalizer.

Installation Clearances:

The Rethermalizer needs clearance around it for proper operation. Adequate clearances allow for servicing and proper burner operation. The clearances shown below are for cooker installation in combustible and noncombustible construction.

	Combustible Construction	Non-Combustible Construction
Back	6"	0"
Sides	6"	0"
Floor - Combustible	6"	6"

Gas Connection (On Gas machines only):

Your Rethermalizer will give you peak performance when the gas supply line is of sufficient size to provide the correct gas flow. The gas line must be installed to meet the local building codes or National Fuel Gas Code (NFPA 54-1984) and ANSI Z223.1 Latest Edition. In Canada, install the Rethermalizer in accordance with CAN/CGA-B149.1 or .2 and local codes. Gas line sizing requirements can be determined by your local gas company by referring to National Fuel Gas Code, Appendix C, Table C-4 (natural gas) and Table C-16 (propane). The gas line must be large enough to supply the necessary amount of fuel to all appliances. The burner manifold operating pressure should be as specified on the data plate attached to the inside of the door. Other factors that are used to determine the piping requirements are BTU requirements of the appliances being connected and the length of pipe between the meter (main shut off) and the appliances.

Fuel Types - Each Rethermalizer is equipped to work with one type of fuel. The type of fuel with which the appliance is intended to operate is stamped on the data plate attached to the inside of the door.

Gas Line Connection - Connect the Rethermalizer to the gas supply line with a connector that complies with the Standard for Connectors for Movable Gas Appliances (ANSI Z21.69-Latest Edition). If you are installing a unit with casters use a quick disconnect discussed in the Quick Disconnect installation instruction. Connect the gas line to the Rethermalizer using a pipe joint sealant that is resistant to liquefied petroleum. If the Rethermalizer was disconnected during the fuel line testing, use a solution of soap and water to leak test the new connection.

NOTICE

NEVER use an adaptor to make a smaller gas supply line fit the cooker connection. This may not allow proper gas flow for optimum burner operation, resulting in poor cooker performance.

Quick Disconnect Gas Connection - Units equipped with casters must be installed with connectors that comply with the Standard for Connectors for Movable Gas Appliances, ANSI Z21.69-Latest Edition, and Addenda Z21.69A-Latest Edition. This connection should include a quick disconnect device that complies with the Standard for Quick Disconnect Devices for Use With Gas Fuel , ANSI Z21.41-Latest Edition. When installing a quick disconnect you must also install a means for limiting the movement of the rethermalizer. This device will prevent the gas line or the quick disconnect from being strained. The restraining device should be attached to the cooker on the back panel as shown in the illustration. The quick disconnect, hose, and restraining device can be obtained from your dealer.

Fuel Supply Line Leak and Pressure Testing - The fuel supply system must be tested before the Rethermalizer is used. If the fuel line is going to be tested at a pressure greater than (>) 1/2 PSIG (3.45 kPa), make sure that the unit is disconnected from the fuel line. If the fuel line is to be tested at a pressure equal to or less than (\leq) 1/2 PSIG (3.45 kPa), the Rethermalizer can be connected but the unit's gas valve must be shut. Test all gas line connections for leaks with a solution of soap and water when pressure is applied.

Plumbing Connections:**CAUTION**

If the water supply is in excess of 50 PSI it must have a pressure regulator installed to limit the Rethermalizers Input Water Pressure to a MAXIMUM of 50 PSI. Your Rethermalizer is equipped with an Anti Siphon Valve (Non Return Valve) located on the inlet fitting of the cook tank. Should your water supply lose pressure, this device will preclude siphoning of the tank contents into the water supply.

The plumbing installation should be done by a licensed plumber and must comply with local and national codes. The water inlet line on the Rethermalizer is located on the front right side of the unit. This line feeds water to the auto fill valves through the manual shut-off valves also located on the back of the unit. A drain line for each tank is underneath the unit and can be inserted into a drainage system. The drain lines for each tank are connected together to form a single common drain line. The drain line also has the overflow line from each tank connected to it. This connection is made after the drain valve to provide an unobstructed overflow path.

Electrical Connection:

On gas machines - The electrical service used by the Rethermalizer must comply with local codes. If there are no local codes that apply, refer to the National Electrical Code (NEC) to install the service. In Canada refer to CSA Standard C22.1 and local codes. Wiring diagrams are provided inside the front panel of the Rethermalizer. The power requirements for the unit are shown below.

	Input Voltage	BTU/HR	Current per Unit	Phase
Gas machines	120 VAC	55,000	0.5 Amps	1
	240 VAC	55,000	0.25 Amps	1

The Gas Rethermalizer has one power cord which supplies power to the unit's controls. The unit must be grounded in accordance with local code; if there is not a local code, comply with NEC ANSI/NFPA No. 70-Latest Edition. It is advised that these power cords be plugged into a wall receptacle supplied from the ventilation control. This will ensure that the Rethermalizer can not be operated unless the ventilator is also on to provide proper ventilation. Disconnect power to the Rethermalizer before cleaning or servicing.

On electric machines - The electrical service used by the Rethermalizer must comply with local codes. If there are no local codes that apply, refer to the National Electrical Code (NEC) to install the service. In Canada refer to CSA Standard C22.1. Wiring diagrams are provided inside the front panel of the Rethermalizer. The power requirements for the unit are shown below.

Electric machines	Input Voltage	Power	Current 1 Phase	Current 3 Phase
	208 VAC	8 KW	38 Amps	22 Amps
	220 VAC	9 KW	41 Amps	24 Amps
	240 VAC	10 KW	44 Amps	26 Amps

Ventilation and Fire Safety Systems (Gas machines only):

Your new Rethermalizer must have proper ventilation to function safely and properly. Exhaust gas temperatures can reach as high as 1200°F. Therefore, it is very important to install a fire safety system. Your ventilation system should be designed to allow for easy cleaning. Frequent cleaning of the ventilation system and the Rethermalizer will reduce the chances of fire. Table 1-1 provides a list of reference documents that provide guidance on ventilation and fire safety systems. This table is not necessarily complete. Additional information can be obtained from the American Gas Association, 8501 East Pleasant Valley Road, Cleveland, OH 44131.

WARNING

Never stand on the rethermalizer to service or clean the hood. This can be both damaging to the machine and hazardous to your health.

CAUTION

Ensure that your ventilation system does not cause a down draft at the unit's flue opening. Down drafts will not allow the Rethermalizer to exhaust properly and will cause overheating which may cause permanent damage. Damage caused by downdrafts will not be covered under equipment warranty. NEVER allow anything to obstruct the flow of combustibles or ventilation exiting from the unit's flue. DO NOT put anything on top of the flue area. Leave at least 18 inches of open space between the Rethermalizer's flue vent opening and the intake of the exhaust hood.

Table 1 Ventilation and Fire Safety References

Topic	Underwriters Laboratory Document	National Fuel Gas Code Document
Grease Extractor Ventilation Hood Filter Unit	ANSI/UL 710-Latest Edition ANSI/UL 705-Latest Edition ANSI/UL 586-Latest Edition	ANSI/NFPA 96-Latest Edition ANSI/NFPA 96-Latest Edition ANSI/NFPA 96-Latest Edition ANSI/UL 900-Latest Edition
Types of Fire Extinguishers and Detection Equipment		
CO ₂ Dry Chemical Water Foam Sprinklers Smoke Detectors Fire Detection Thermostats	ANSI/UL 154-Latest Edition ANSI/UL 299-Latest Edition ANSI/UL 626-Latest Edition ANSI/UL 199-Latest Edition ANSI/UL 268-Latest Edition ANSI/UL 521-Latest Edition	ANSI/NFPA 12-Latest Edition ANSI/NFPA 17-Latest Edition ANSI/NFPA 13-Latest Edition ANSI/NFPA 11-Latest Edition ANSI/NFPA 13-Latest Edition ANSI/NFPA 72B-Latest Edition ANSI/NFPA 72B-Latest Edition

NOTICE

NEVER connect the blower hood vent directly to the flue openings. The direct flow of air will cause poor temperature recovery, poor ignition, inefficient operation of the Rethermalizer, and could extinguish the pilot.

CAUTION

In the event of a fire, use ONLY a dry chemical extinguisher. The extinguisher should be a B/C or A/B/C type extinguisher that contains sodium bicarbonate or potassium bicarbonate.

Chapter 3: Initial Adjustments

Visual Checks and Equipment Locations:

Before you begin filling and adjusting the unit, perform the following visual checks:

- a. Move the Rethermalizer to its permanent cooking position and lock the caster wheels, attach the restraining cable at the rear of the machine. Ensure that the Rethermalizer drain is lined up with the floor drain.
- b. Check the High Limit probe located inside the tank. Ensure that the mounting screws are tight to prevent the probe from coming loose during operation. Figure 1 shows the location of the High Limit probe, Temperature probe, and the Water Level sensors. Also shown are the over flow stand pipe and the water entry nozzle. Look down inside the Rethermalizer tanks to see the probes.

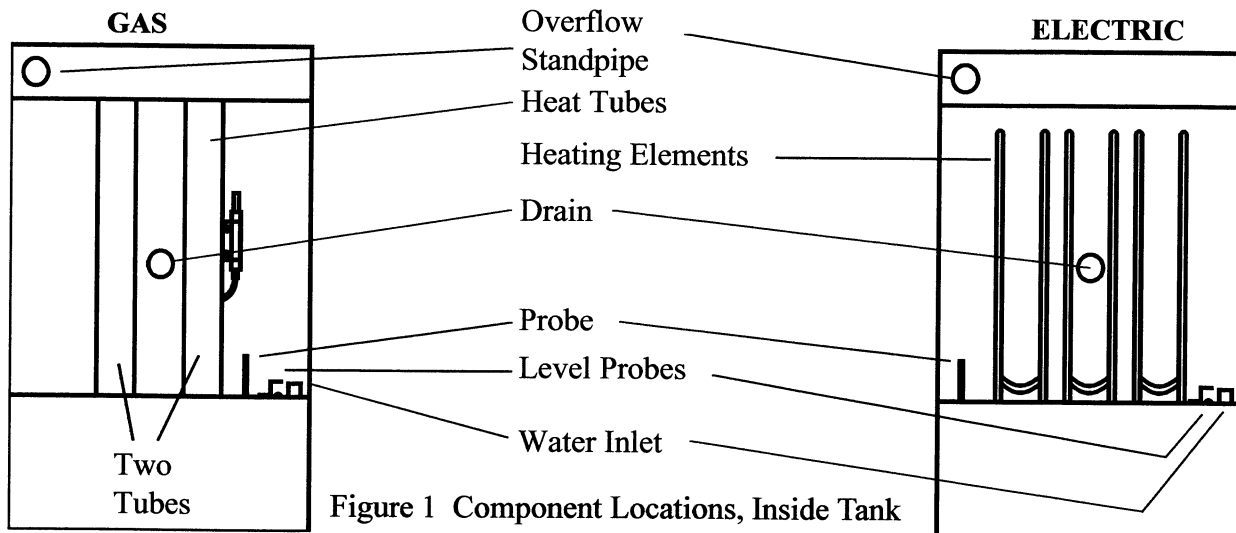

Filling the Rethermalizer:

The Rethermalizer is equipped with an automatic water level maintaining system. To fill the unit with water press the **Ⓢ** key. This causes the solenoid valve to open and supply water to the unit through the fill nozzle in the bottom of the tank. The tank will continue to fill until the water level reaches the level sensors. When both water level sensors are covered the solenoid valve will close stopping the flow of water. During normal operation the automatic fill system will maintain the water level at the proper height.

NOTE

If the water control system turns on while the main burners or elements are running the main burners or elements will turn off. This is normal and will not affect the operation of the Rethermalizer. When the tank refills to the high level probe the solenoid will close and the main burners will relight.

Pilot Light System (Gas machines with Electronic Ignition Pilot only):

There are no adjustments necessary on machines equipped with Electronic Ignition.

Pilot Light System (Gas machines with Standing Pilot Only):

After your Rethermalizer has been installed, it needs to be adjusted to ensure that it will perform as designed. These adjustments must be performed by a **qualified person**. To perform these adjustments the following tools will be needed:

Manometer (low pressure gauge) DC Millivolt Meter

The Manual pilot light system lights the main burners and stays lit until the gas valve knob is turned to the OFF position. The pilot light receives its gas supply through the gas valve. To light the pilot perform the procedure below.

- Each side of the unit has its own gas supply valve. This allows one side to be serviced while the other is operating. These gas valves should normally be open.
- Turn the gas valve knob to the PILOT position and push in on the knob. Hold the knob in for approximately one minute to purge the air out of the line. Hold a flame to the pilot light until the pilot ignites. This may take a little while the first time you light the pilot because of air in the lines. Once lit, hold the knob in for approximately 60 seconds and then release. The pilot should now remain lit.
- Turn the gas knob counterclockwise to the ON position.
- If the pilot goes out repeat step c. The first time the pilot is lit, when the machine is new or after service on the gas line, you will need to purge the air form the system.
- Press the  key. The electronic control unit will come on and display the temperature of the water. There will also be a red light lit between the left and middle digits of the display. This light indicates that the electronic control unit is calling for heat. If the water level is below the low level sensor the water solenoid valve will open and fill the tank.
- When the water in the tank is at the correct level the main burner will light and be controlled by the electronic control unit. The pilot burner will remain lit regardless of the switch position.
- The burners or elements will remain lit until the temperature reaches 195°F where they will turn off. While the burners are off the red light in the electronic display will be off. The burners will maintain the water temperature between 194°F and 196°F.
- When the Temperature controller is turned ON the water level will be maintained automatically by the water fill system.

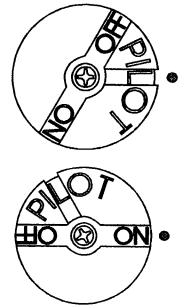

Pilot Flame Adjustment - The pilot flame should be adjusted to produce between 400 ± 50 millivolts output from the thermopile. Figure 2 shows the pilot assembly with examples of the incorrect and correct pilot size. Example A illustrates a pilot size that is too small to produce sufficient millivolt output. Example B is the correct size for proper millivolt output.

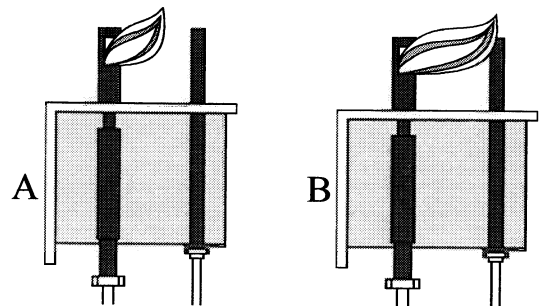

Figure 2 Pilot Assembly, Flame Adjustment

- This test requires the DC millivolt meter set to a scale of 0-1000mV. Using leads with sharp probes will help in taking the required reading.

- b. Locate the thermopile wires coming from the High Limit box going to the gas valve. The wire insulation size decreases near the gas valve connections.
- c. Connect the negative (-) test probe to the pilot mounting bracket (ground).
- d. Connect the positive (+) test probe to one of the High Temperature Limit terminal connections. If the reading is within the specified range remove the test leads, the test is now complete. If the reading is above or below the specified range continue to step e.
- e. Remove the pilot flame adjustment cover.

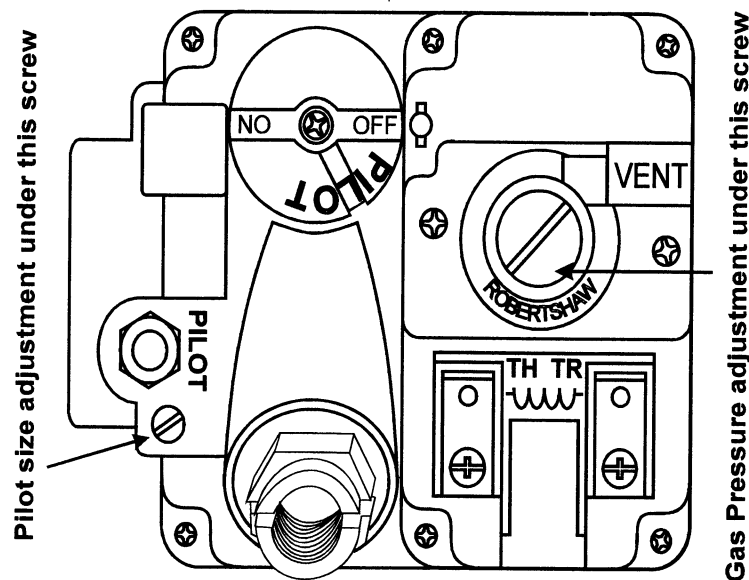

Figure 3 Gas Valve Showing Location of the Pressure Regulator and Pilot Adjuster.

- f. Turning the flame adjusting screw clockwise lowers the flame and the millivolt output. Turning the screw counterclockwise increases flame size and millivolt output.
- g. Rotate the screw in the direction to achieve a reading of 400 ± 50 mV.

NOTE

Allow 3 to 5 minutes between flame adjustments to allow the reading to settle.

- h. Replace the pilot flame adjusting screw cover, remove the test leads, the test is now complete.



Main Burner System (Gas machines only):

For the burners to work the gas supply valve must be open and the Temperature controller must be on. The main burners receive gas from the main gas supply through the gas valve. When the Temperature controller calls for heat (and the tank is at the proper water level), the gas valve opens. When the main burners are operating, perform the burner adjustments in the following procedure. Figure 4 illustrates the different conditions possible for the main burner.

NOTE (Gas machines only)

A properly installed gas supply system will deliver 7.0 ± 2.0 " w.c. Natural gas (12.0 ± 1.0 " w.c. LP) to all appliances connected to the line, operating at full demand.

Burner Adjustment - The burners must be adjusted to deliver optimum flame. Adjust the burner flame using the following procedure.

- a. Ensure that the gas valve knob is in the PILOT or OFF position. Remove the manifold pressure tap plug and connect an accurate pressure gauge (range of 0-16" w.c. in 0.1" increments) or manometer.
- b. On Standing Pilot machines - Light the pilot burner for the unit being tested. Press the  key for Digital controls or the ON/OFF switch for Computer controls. This will cause the main burners to come on.
- c. The pressure reading should be the same, ± 0.1 ", as that marked on the data plate inside the door. If the pressure is correct go to step f, if not, adjust the pressure.
- d. To adjust the pressure, remove the regulator adjustment screw cover (see Figure 1-3). Use a flat tip screwdriver to adjust the screw until the proper pressure is reached. Turning the screw clockwise will increase the pressure, counterclockwise will decrease the pressure.
- e. When the pressure is correct, install the regulator adjustment screw cover.
- f. To remove the pressure gauge, press the  key for Digital controls or the ON/OFF switch for computer controls. Turn the gas valve knob to PILOT or OFF. Remove the gauge and install the pressure tap plug using a small amount of sealing compound.
- g. Now that the pressure is set for proper operation, adjust the main burner flame. Unlock the air collars by loosening the set screw for the collars. Turn the gas valve knob to ON and press the  key to light the main burners.
- h. Adjust the shape and size by raising or lowering the air collars to achieve a soft blue flame with well defined inner cones.
- i. When the flames have been properly adjusted, lock the collars in place by tightening the set screw.

Initial Cleaning:

When the Rethermalizer is shipped, many of its parts are covered with a thin coat of oil for protection. Before the unit is ready for use it must be cleaned to remove the oil coating and any foreign matter that may have accumulated during storage and shipment. Perform the cleaning as described below.

- a. Fill the tank with water and add the sample packet of Pitco Fryer Cleaner that was shipped with your new Rethermalizer. (If Pitco Fryer Cleaner is not available a mild detergent may be substituted.)
- b. Turn the Rethermalizer on and allow it to reach normal operating temperature. Allow the unit to soak for a short time to remove the oil coating. Use the supplied cleaning brush to clean the tank.

- c. When the cleaning is complete, turn the Rethermalizer OFF and drain the water.
- d. When the tank has cooled, rinse it thoroughly with cool water. Continue to rinse the tank until the cleaner has been rinsed from the tank.
- e. Now that the tank is clean, you are ready to fill and operate the Rethermalizer.

High Limit Switch:

Gas machines - The High Limit switch will shut down the unit if the temperature reaches 250°F.

Electric machines - Electric Rethermalizers are NOT equipped with Hi Limit switches.

Chapter 4: Operating Instructions

This chapter describes how to operate your Rethermalizer to obtain the best performance.

Filling the Rethermalizer:

The Rethermalizer is equipped with an automatic water level maintaining system. To fill the unit with water press the ① (ON/OFF) key for Digital controls, press the ON/OFF switch for Computer controls. This causes the solenoid valve to open and supply water to the unit through the fill nozzle in the bottom of the tank. The tank will continue to fill until the water level reaches the level sensors. When both water level sensors are covered the solenoid valve will close stopping the flow of water. During normal operation the automatic fill system will maintain the water level at the proper height.

CAUTION

The Rethermalizer has been installed using restraining devices to prevent accidental tipping or movement. Do not attempt to move the fryer when it has hot liquid in it. Splashing hot liquids can cause severe burns.

Manual Operation of the Water Fill System:

Although the water fill system is completely automatic, the solenoid valve can be bypassed manually to fill the tank. To bypass the water solenoid valve open the valve in the bypass pipe. This should only be done if the solenoid valve fails and the Rethermalizer needs to be operated. When finished filling the Rethermalizer ensure that the solenoid manual bypass valve is returned to its normal position.

NOTE

When the water solenoid is bypassed the automatic water fill system **WILL NOT** maintain the water level. The water level control system should remain in automatic during normal operation.

Start-Up and Use:

- a. Light the pilot light if you have a gas machine with a standing pilot
- b. Press the ① key to turn the Digital controller ON or the ON/OFF switch if you have a Computer. If the water level in the tank is not at the proper operating height the solenoid valve will open and fill the tank.
- c. When the water reaches the correct operating level, the heating system will begin to heat the water and the controller will take over and control the water temperature. When the controller is calling for heat the red LED "Heating Light" will also be on.
- d. The heating system will remain on until 195°F is reached, at which time it will automatically turn off. The Rethermalizer is now up to temperature and ready to accept the food to be heated.
- e. The controller will maintain the water temperature at approximately 195°F and the water fill system will keep the water at the correct level.

Shutdown:

Gas machines with standing pilots - There are two shutdown modes for the Rethermalizer, STANDBY and COMPLETE. The standby mode removes the ability for the unit's main burners to cycle. Complete shutdown turns off the gas supply to the unit.

STANDBY Press the  key to turn the Digital controller OFF, or the ON/OFF switch to turn the Computer OFF. Depress and turn the gas valve knob clockwise to the PILOT position. The Rethermalizer is now in Standby and can remain this way for only brief periods of time. NEVER leave the unit in standby overnight.

COMPLETE To completely shut down the Rethermalizer, place the machine in STANDBY and continue to turn the gas valve knob clockwise to the OFF position.

Gas machines with Electronic Ignition pilots - These machines can only be shut down to a COMPLETE condition. Press the  key to turn the Digital controller OFF, or the ON/OFF switch to turn the Computer OFF. Depress and turn the gas valve knob clockwise to the OFF position.

Electric machines - Press the  key to turn the controller OFF.

Power Failure:

NOTICE







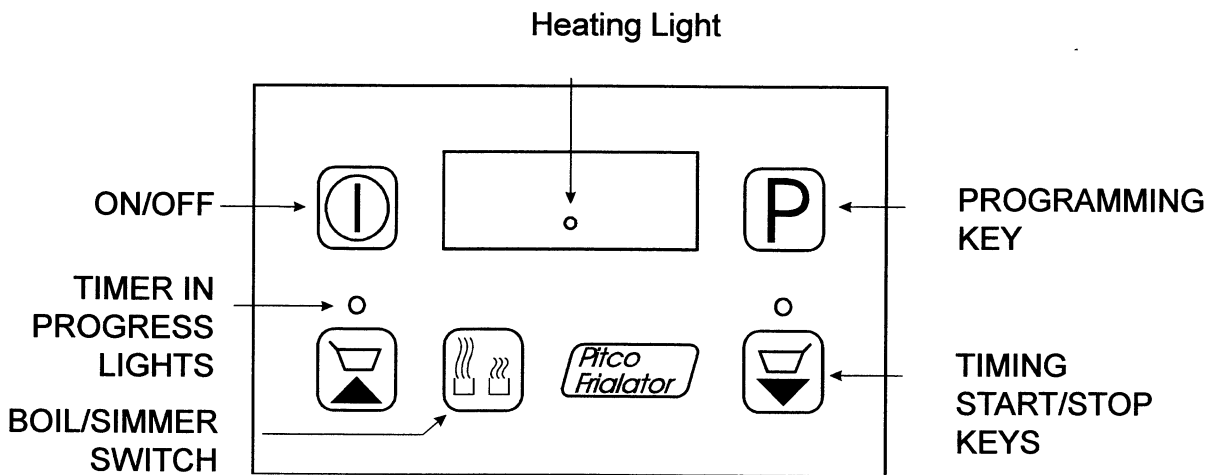

No attempts should be made to operate the fryer during power outages.













If power is removed from the Rethermalizer for any reason during operation, the unit will shut down automatically. Wait five minutes after power is restored before restarting the Rethermalizer. This will give any gas fumes in the burner time to dissipate. To restart the unit, follow the Start-Up and Use procedures as you normally would.

Programming the Digital Controller:







Key Recognition - Following is a brief description of what each keys function is:





- Use the  key to turn the controller ON and OFF.
- Use the  key to switch between the Boil and Simmer mode.  or  will be displayed
- Use the  key to start and stop the left hand timer.  will be displayed.
- Use the  key to start and stop the right hand timer.  will be displayed.
- Use the  key for programming purposes.





Programming times - Press the  key to enter the programming mode.  or  will show in the display. If  shows in the display the controller has been set to the PASSWORD mode. Use   then   as a password, and the display will show . Use  or  to change the desired time setting. When scrolling through the time settings, audible "clicks" can be heard to show that the time is changing. Once a new time has been set press the  key two times to exit the programming mode.





Advanced programming - There are several items that can be changed to accommodate certain specific cooking needs. Follow the instructions below for the desired changes:







To enter the programming mode press the  key and then release it, press the  key again and hold it for 5 seconds.

Setting the operating temp Press the  key and then use the  and  keys to scroll through the available temperature settings. The controller may be set anywhere between 145°F (63°C) and 205°F (96°C).



Temperature display mode Press the  key again and then use the  and  keys to scroll between  for ON and to  for OFF.

Lock mode Press the  key again and then use the  and  keys to scroll between  (Locked) or  (Unlocked).

Fahrenheit or Celcius Press the  key again and then use the  and  keys to scroll between  or .

Quantity of Basket Lifts Press the  key again and then use the  and  keys to scroll between ,  and . This setting will have no effect on your Rethermalizer.

Return to program start Press the  key again and the programming will return to _____

To exit this mode press the  key and hold it for 2 seconds. If you have not exited this programming mode and wish to go back to a previously selected area keep pressing the  key until you reach the area you need.

THE INTELLIFRY COMPUTER

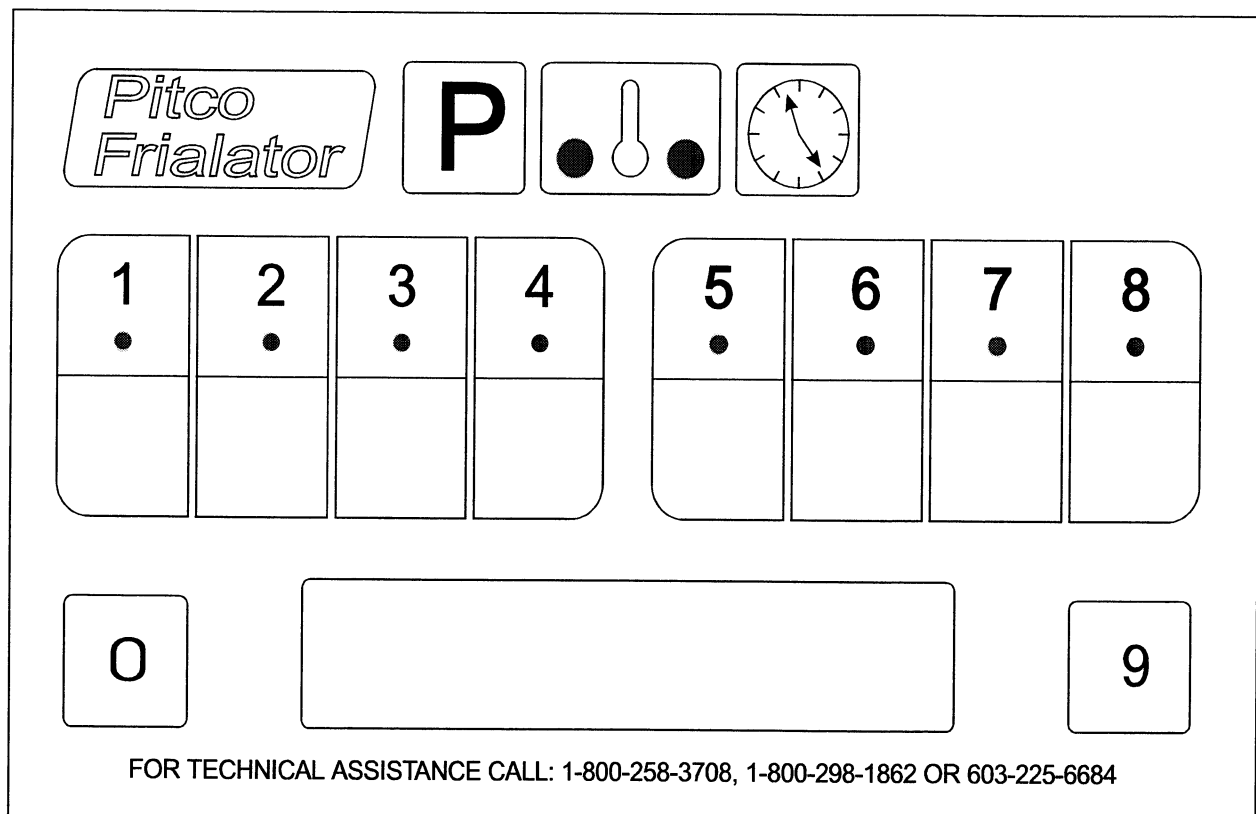

Your computer is fully programmable to satisfy all of your cooking needs. To ensure proper product preparation, always refer to in house guidelines for cooking when changing the program. Each of the programmable features are described in the following paragraphs.

Cook Time. The cooking time for a product can be changed to meet the needs of any recipe. The time set for a product is the time necessary at the SET temperature to cook the product. These times can be displayed in Hours, Minutes and Seconds. The cook time is displayed by depressing the Product Key ONE time. The COOK time can be cancelled by depressing the Product Key THREE times.

Temperature. The water temperature for the cooker is set and maintained by the computer. Only one SET temperature is allowed in each computer.

Computer or Probe Failure. If there is a probe (device used for sensing the temperature of the water in the cook tank) failure An alarm will automatically sound and FAILURE will display.

Checking the Temperature functions and Cooking times.





To check the ACTUAL temperature press the  once.

To check the SET temperature press the  key two times. After 5 seconds the display will return to normal.

To check the COOK and HOLD times press the  followed by the product key you wish to check. The times will be displayed in sequence followed by a short pause, finally returning to the normal cook mode.



When the computer is calling for heat the two lights in the lower corners of the  key will illuminate.

Programming Cook & Hold Times.

To set the COOK time press the  key then the  key. Enter the desired product key and change the desired time by using the numbered keys. Press the  key and the HOLD time will be displayed and may be changed using the numbered keys. Press the  key again and the next product key may be programmed. Pressing the  key two times at any point during this procedure will return you to the normal cook mode.



Programming Cooking Temperature.







This setting determines the thermostat setting for the computer. Unlike conventional thermostats, once the computer is set it will never need calibration. Set the desired temperature by performing the following procedure.



Press the  key followed by the  key. The new COOK temperature may now be set using the numbered keys. Pressing the  key two times at any point during this procedure will return you to the normal cook mode.

Level 2 Programming.

There are several features that merit mention at this point. Their programming functions are explained along with their descriptions.

To enter the level 2 programming mode press the  key followed by the  key. If a password has been set you will be asked to enter it, if you do not remember what the password is use "6684". This will allow you to program these basic functions and reset the password.

To choose between "°F" or "°C" press the  key and use the  key to toggle between the options. To set "PASSWORD REQUIRED" or "NO PASSWORD" press the  key and use the  key to toggle between the two options. To set a new password press the  key and enter a four digit password. Press the  key again and the display will return to the normal cook mode. To continue setting level options in the level 2 programming you must re enter to level 2 programming mode in the same manner as before.

To set the beeper volume press the  key and use the  key to toggle between the options.

Pressing the  key two times at any point during this procedure will return you to the normal cook mode.

To exit the level 2 programming mode at any time press the  key two times. This will return you to the normal cook mode.

Chapter 5: Maintenance, Adjustments, and Service

This chapter provides you with the information and procedures necessary to perform Rethermalizer maintenance, adjustments, and service. If after performing maintenance on your Rethermalizer it does not operate properly, contact your authorized service center.

WARNING

The power supply must be disconnected before servicing or cleaning the appliance.

NOTICE (Gas machines)

The unit may have casters and therefore has a quick disconnect gas connection and a restraining device. These are located in the rear of the machine. Care should be exercised when moving the unit out to be serviced. When you are moving the unit back into place ensure that you connect the restraining device before you move the unit back into place. You should also be careful not to kink the gas or water hose. The casters are equipped with locking devices on the front casters only. Make sure the casters are set to the locked position before attempting to run the machine.

Daily Cleaning:

WARNING

The power supply must be disconnected before servicing or cleaning the appliance

CAUTION

Do NOT use chlorine based cleaning agents in your tank, the chlorine will attack the metal and lead to premature failure.

Your Rethermalizer should be cleaned every day to maintain peak performance and appearance. Use warm water with a mild detergent, rinsing with clear water, and drying with a soft, cloth to clean exterior surfaces. Wipe down the unit using a clean soft cloth to clean up water spillage. Use a nonabrasive scouring powder or pad to clean stains if necessary.

Weekly Cleaning:

The continuous filling and evaporation of water from the Rethermalizer will cause deposit build up around the tank. At least once a week the unit should be thoroughly cleaned to remove these deposits and generally clean the unit. Perform the cleaning as described below.

- a. Fill the tank with water and add the sample packet of Pitco Fryer Cleaner that was shipped with your new Rethermalizer. (If Pitco Fryer Cleaner is not available a mild detergent may be substituted.)
- b. Turn the Rethermalizer on and allow it to reach normal operating temperature. Allow the unit to soak for a short time to remove the oil coating. Use the supplied cleaning brush to clean the tank. On

Gas machines special care should be taken to clean the crevices where the heat tubes meet the front and rear of the tank. You can use a non-abrasive scouring powder or pad to clean stains if necessary. When cleaning around the High Limit bulb (on gas units only) be careful not to damage the bulb or its capillary tube.

- c. When the cleaning is complete, press the  key to turn the Digital controller OFF, or the ON/OFF switch to turn the Computer OFF. Drain the water.
- d. When the tank has cooled, rinse it thoroughly with cool water. Continue to rinse the tank until the cleaner has been rinsed from the tank.
- e. Inspect the water level sensors located under the brackets in the front of the tank. If they are covered with or have any debris build up, clean them with a scouring pad.
- f. Now that the tank is clean, you are ready to fill and operate the Rethermalizer.
- g. If during cleaning, or any other reason, the restraining device is disconnected, it must be reconnected and the Rethermalizer returned to its original cooking position before operated.

Flue and Baffle Inspection (Gas machines only):

It is recommended that once every six months you examine the flue area and the burner tube baffles. With the cooker cooled down check for corrosion or blockage of the flue and erosion of the baffles. Ensure that the cooker is shutdown and do not turn it on during the examination.

WARNING

Examination of the flue area during cooking may cause bodily injury.

Service:

If servicing is required, electrical components can be accessed through the front panel. To gain access to the front panel, remove the four screws on the front panel. Remove the front panel and unplug the wiring harness, set aside with the four screws for installation after servicing is complete. An electrical diagram is supplied inside the front panel for use by an authorized service person. There is also an electrical diagram in the back of this manual. The electrical diagram can be used to verify the proper operation of the electrical systems. After servicing is complete, the diagram should be replaced for future reference and the front panel installed in the reverse order of removal. (If the electrical diagram has been removed and a service technician is working on the machine without the diagram, it will cause the technician to take longer in his repair, this may cost you more for the final repair.)

WARNING

To prevent burns, always ensure that the unit is completely SHUT DOWN and COOLED before working on the Rethermalizer. On Gas machines DO NOT break any gas connections until the unit is disconnected from the gas supply line.

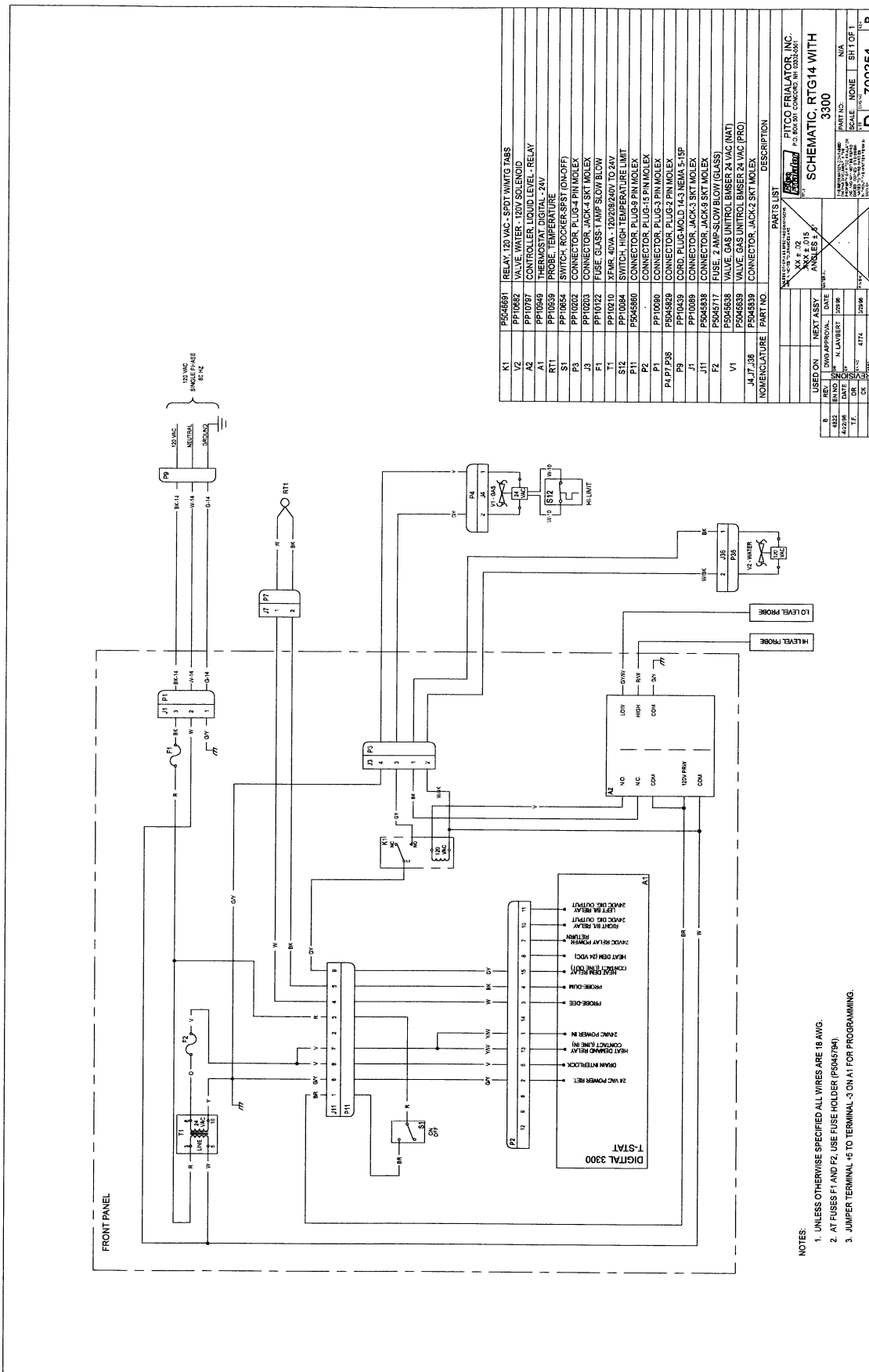

- NOTES:
1. UNLESS OTHERWISE SPECIFIED ALL WIRES ARE 18 AWG.
 2. AT FUSES F1 AND F2, USE FUSE HOLDER (P5045794).
 3. JUMPER TERMINAL #5 TO TERMINAL #3 ON A1 FOR PROGRAMMING.

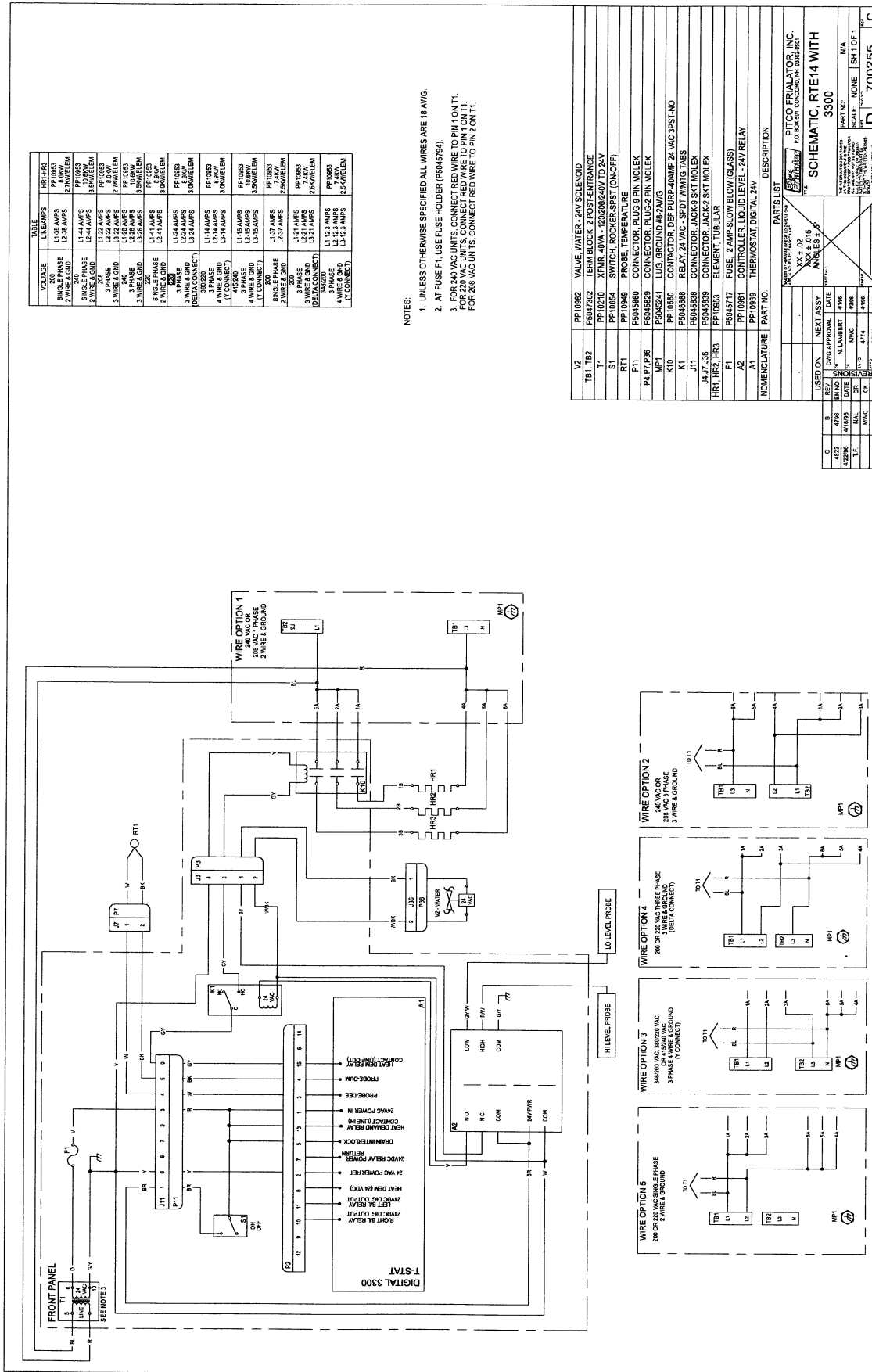

VOLTAGE	WIRE/PHASE	WIRE/PHASE
2 WIRE/2 PHASE	L1-18 AMPS	RT1-18
2 WIRE/1 PHASE	L2-18 AMPS	RT1-18
3 WIRE/3 PHASE	L1-14 AMPS	RT1-14
3 WIRE/2 PHASE	L2-14 AMPS	RT1-14
3 WIRE/1 PHASE	L3-14 AMPS	RT1-14
3 WIRE/3 PHASE	L1-12 AMPS	RT1-12
3 WIRE/2 PHASE	L2-12 AMPS	RT1-12
3 WIRE/1 PHASE	L3-12 AMPS	RT1-12
3 WIRE/3 PHASE	L1-10 AMPS	RT1-10
3 WIRE/2 PHASE	L2-10 AMPS	RT1-10
3 WIRE/1 PHASE	L3-10 AMPS	RT1-10
3 WIRE/3 PHASE	L1-8 AMPS	RT1-8
3 WIRE/2 PHASE	L2-8 AMPS	RT1-8
3 WIRE/1 PHASE	L3-8 AMPS	RT1-8
3 WIRE/3 PHASE	L1-6 AMPS	RT1-6
3 WIRE/2 PHASE	L2-6 AMPS	RT1-6
3 WIRE/1 PHASE	L3-6 AMPS	RT1-6
3 WIRE/3 PHASE	L1-4 AMPS	RT1-4
3 WIRE/2 PHASE	L2-4 AMPS	RT1-4
3 WIRE/1 PHASE	L3-4 AMPS	RT1-4
3 WIRE/3 PHASE	L1-3 AMPS	RT1-3
3 WIRE/2 PHASE	L2-3 AMPS	RT1-3
3 WIRE/1 PHASE	L3-3 AMPS	RT1-3
3 WIRE/3 PHASE	L1-2 AMPS	RT1-2
3 WIRE/2 PHASE	L2-2 AMPS	RT1-2
3 WIRE/1 PHASE	L3-2 AMPS	RT1-2
3 WIRE/3 PHASE	L1-1.5 AMPS	RT1-1.5
3 WIRE/2 PHASE	L2-1.5 AMPS	RT1-1.5
3 WIRE/1 PHASE	L3-1.5 AMPS	RT1-1.5

- NOTES:
- UNLESS OTHERWISE SPECIFIED ALL WIRES ARE 18 AWG.
 - AT FUSE F1, USE FUSE HOLDER (P5045794).
 - FOR 240 VAC UNITS, CONNECT RED WIRE TO PIN 1 ON T1.
 - FOR 346 VAC UNITS, CONNECT RED WIRE TO PIN 1 ON T1.
 - FOR 208 VAC UNITS, CONNECT RED WIRE TO PIN 2 ON T1.

NO.	DESCRIPTION	PART NO.
V1	VALVE WATER - 24V SOLENOID	PF10862
TB1	BACK-2 POSITION RANGE	PF10216
T1	TRANSFORMER	PF10824
S1	SWITCH FOCUSED SST (ON-OFF)	PF10846
RT1	PROBE TEMPERATURE	PF04860
P11	CONNECTOR PLUG-2 PIN MOLEX	PF04829
P4 P7 P36	CONNECTOR PLUG-2 PIN MOLEX	PF04824
MP1	LUG GROUND #6-2AWG	PF10660
K10	CONTACTOR DEF-PURP-40AMP 24 VAC 3PST-NO	PF04888
K1	RELAY 24 VAC - SPDT WMTG TABS	PF04888
J11	CONNECTOR JACK-2 SKT MOLEX	PF04839
J4 J7 J35	CONNECTOR JACK-2 SKT MOLEX	PF04839
HRT HRZ HR3	ELEMENT TUBULAR	PF04877
F1	FUSE 2 AMP-SLOW BLOW (GLASS)	PF10881
A1	CONTROLLER LIQUID LEVEL - 24V RELAY	PF10881
AZ	THERMOSTAT DIGITAL 24V	PF10881

REVISION	DATE	DESCRIPTION
1	01/08/00	ISSUED FOR PRODUCTION
2	01/08/00	REVISED TO ADD OPTION 5
3	01/08/00	REVISED TO ADD OPTION 4
4	01/08/00	REVISED TO ADD OPTION 3
5	01/08/00	REVISED TO ADD OPTION 2
6	01/08/00	REVISED TO ADD OPTION 1

USED ON	DATE	BY
432	01/08/00	JL
432306	01/08/00	JL
TF	01/08/00	JL

NO.	DESCRIPTION	PART NO.
P11	CONNECTOR PLUG-2 PIN MOLEX	PF04829
P4 P7 P36	CONNECTOR PLUG-2 PIN MOLEX	PF04824
MP1	LUG GROUND #6-2AWG	PF10660
K10	CONTACTOR DEF-PURP-40AMP 24 VAC 3PST-NO	PF04888
K1	RELAY 24 VAC - SPDT WMTG TABS	PF04888
J11	CONNECTOR JACK-2 SKT MOLEX	PF04839
J4 J7 J35	CONNECTOR JACK-2 SKT MOLEX	PF04839
HRT HRZ HR3	ELEMENT TUBULAR	PF04877
F1	FUSE 2 AMP-SLOW BLOW (GLASS)	PF10881
A1	CONTROLLER LIQUID LEVEL - 24V RELAY	PF10881
AZ	THERMOSTAT DIGITAL 24V	PF10881

NO.	DESCRIPTION	PART NO.
V1	VALVE WATER - 24V SOLENOID	PF10862
TB1	BACK-2 POSITION RANGE	PF10216
T1	TRANSFORMER	PF10824
S1	SWITCH FOCUSED SST (ON-OFF)	PF10846
RT1	PROBE TEMPERATURE	PF04860
P11	CONNECTOR PLUG-2 PIN MOLEX	PF04829
P4 P7 P36	CONNECTOR PLUG-2 PIN MOLEX	PF04824
MP1	LUG GROUND #6-2AWG	PF10660
K10	CONTACTOR DEF-PURP-40AMP 24 VAC 3PST-NO	PF04888
K1	RELAY 24 VAC - SPDT WMTG TABS	PF04888
J11	CONNECTOR JACK-2 SKT MOLEX	PF04839
J4 J7 J35	CONNECTOR JACK-2 SKT MOLEX	PF04839
HRT HRZ HR3	ELEMENT TUBULAR	PF04877
F1	FUSE 2 AMP-SLOW BLOW (GLASS)	PF10881
A1	CONTROLLER LIQUID LEVEL - 24V RELAY	PF10881
AZ	THERMOSTAT DIGITAL 24V	PF10881

NO.	DESCRIPTION	PART NO.
V1	VALVE WATER - 24V SOLENOID	PF10862
TB1	BACK-2 POSITION RANGE	PF10216
T1	TRANSFORMER	PF10824
S1	SWITCH FOCUSED SST (ON-OFF)	PF10846
RT1	PROBE TEMPERATURE	PF04860
P11	CONNECTOR PLUG-2 PIN MOLEX	PF04829
P4 P7 P36	CONNECTOR PLUG-2 PIN MOLEX	PF04824
MP1	LUG GROUND #6-2AWG	PF10660
K10	CONTACTOR DEF-PURP-40AMP 24 VAC 3PST-NO	PF04888
K1	RELAY 24 VAC - SPDT WMTG TABS	PF04888
J11	CONNECTOR JACK-2 SKT MOLEX	PF04839
J4 J7 J35	CONNECTOR JACK-2 SKT MOLEX	PF04839
HRT HRZ HR3	ELEMENT TUBULAR	PF04877
F1	FUSE 2 AMP-SLOW BLOW (GLASS)	PF10881
A1	CONTROLLER LIQUID LEVEL - 24V RELAY	PF10881
AZ	THERMOSTAT DIGITAL 24V	PF10881

NO.	DESCRIPTION	PART NO.
V1	VALVE WATER - 24V SOLENOID	PF10862
TB1	BACK-2 POSITION RANGE	PF10216
T1	TRANSFORMER	PF10824
S1	SWITCH FOCUSED SST (ON-OFF)	PF10846
RT1	PROBE TEMPERATURE	PF04860
P11	CONNECTOR PLUG-2 PIN MOLEX	PF04829
P4 P7 P36	CONNECTOR PLUG-2 PIN MOLEX	PF04824
MP1	LUG GROUND #6-2AWG	PF10660
K10	CONTACTOR DEF-PURP-40AMP 24 VAC 3PST-NO	PF04888
K1	RELAY 24 VAC - SPDT WMTG TABS	PF04888
J11	CONNECTOR JACK-2 SKT MOLEX	PF04839
J4 J7 J35	CONNECTOR JACK-2 SKT MOLEX	PF04839
HRT HRZ HR3	ELEMENT TUBULAR	PF04877
F1	FUSE 2 AMP-SLOW BLOW (GLASS)	PF10881
A1	CONTROLLER LIQUID LEVEL - 24V RELAY	PF10881
AZ	THERMOSTAT DIGITAL 24V	PF10881

NO.	DESCRIPTION	PART NO.
V1	VALVE WATER - 24V SOLENOID	PF10862
TB1	BACK-2 POSITION RANGE	PF10216
T1	TRANSFORMER	PF10824
S1	SWITCH FOCUSED SST (ON-OFF)	PF10846
RT1	PROBE TEMPERATURE	PF04860
P11	CONNECTOR PLUG-2 PIN MOLEX	PF04829
P4 P7 P36	CONNECTOR PLUG-2 PIN MOLEX	PF04824
MP1	LUG GROUND #6-2AWG	PF10660
K10	CONTACTOR DEF-PURP-40AMP 24 VAC 3PST-NO	PF04888
K1	RELAY 24 VAC - SPDT WMTG TABS	PF04888
J11	CONNECTOR JACK-2 SKT MOLEX	PF04839
J4 J7 J35	CONNECTOR JACK-2 SKT MOLEX	PF04839
HRT HRZ HR3	ELEMENT TUBULAR	PF04877
F1	FUSE 2 AMP-SLOW BLOW (GLASS)	PF10881
A1	CONTROLLER LIQUID LEVEL - 24V RELAY	PF10881
AZ	THERMOSTAT DIGITAL 24V	PF10881

NO.	DESCRIPTION	PART NO.
V1	VALVE WATER - 24V SOLENOID	PF10862
TB1	BACK-2 POSITION RANGE	PF10216
T1	TRANSFORMER	PF10824
S1	SWITCH FOCUSED SST (ON-OFF)	PF10846
RT1	PROBE TEMPERATURE	PF04860
P11	CONNECTOR PLUG-2 PIN MOLEX	PF04829
P4 P7 P36	CONNECTOR PLUG-2 PIN MOLEX	PF04824
MP1	LUG GROUND #6-2AWG	PF10660
K10	CONTACTOR DEF-PURP-40AMP 24 VAC 3PST-NO	PF04888
K1	RELAY 24 VAC - SPDT WMTG TABS	PF04888
J11	CONNECTOR JACK-2 SKT MOLEX	PF04839
J4 J7 J35	CONNECTOR JACK-2 SKT MOLEX	PF04839
HRT HRZ HR3	ELEMENT TUBULAR	PF04877
F1	FUSE 2 AMP-SLOW BLOW (GLASS)	PF10881
A1	CONTROLLER LIQUID LEVEL - 24V RELAY	PF10881
AZ	THERMOSTAT DIGITAL 24V	PF10881



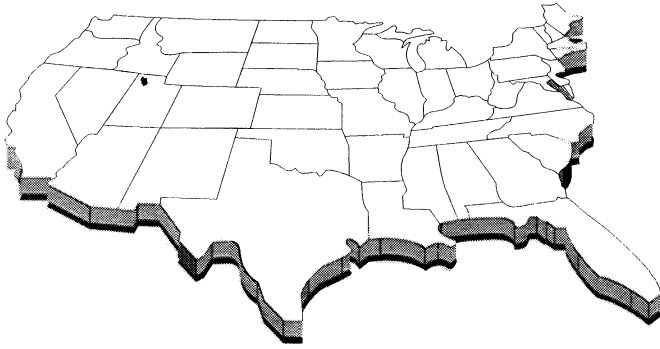

In the event of problems with or questions about your equipment, please contact your local ASAP (Authorized Service and Parts) representative. You can find their number by calling the:

NATIONAL SERVICE COOPERATIVE
1(800)298-1862

To obtain copies of this Installation, Operators and Maintenance Manual at NO CHARGE please contact Pitco Frialator at the following address:

Pitco Frialator Inc.,
P.O.BOX 501
CONCORD, NH 03302-0501

In the event of problems with or questions about your order, please contact the Pitco Frialator factory, from 8:00 a.m. - 5:00 p.m., Eastern Standard Time, Monday through Friday, toll-free at:

(800)258-3708 US and Canada only or
(603)225-6684 World Wide