

# REX AUTOMAT CLASSIC / FUTURA

The continuous dough dividing and rounding machine

Execution: 4 to 6 rows

Weight ranges: 20 - 160 g

Hourly capacity: up to 9000 pieces



*THE BETTER SOLUTION*

## Operating principle

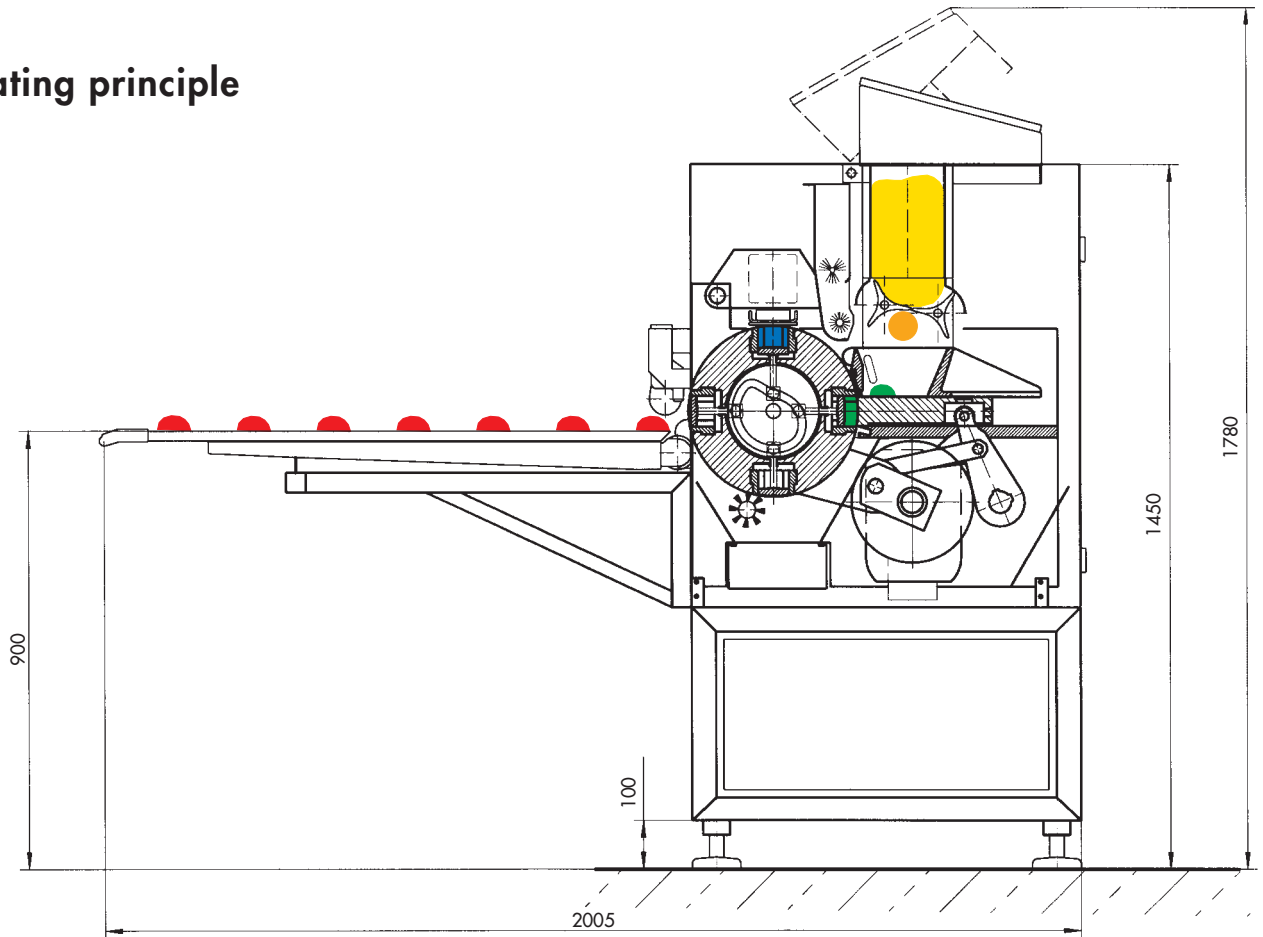

- **gentle dough infeed:** Choose from our wide customised dough hopper programme, from the standard dough hopper with a capacity of approx. 12 litres to a large dough hopper with a capacity of approx. 240 litres
- the **pre-portioning** of the dough is controlled by means of our patented dough infeed system consisting of dough infeed star rollers, dough level sensor and hopper duster
- **gentle dividing** of the dough pieces (dough dividing) according to the well proven **Rex-High-Soft-(HS)-system** by means of a spring protected dough pusher and a cam controlled dividing piston. The excess dough is recycled with hardly any mechanical pressure.
- the **rounding** of the dough pieces occurs in the piston cylinders after the drum has rotated by means of a special rounding plate which is similar to that of a plate rounder. During the rounding process the rounding height is adjusted automatically. Selection of a different dough weight results in an automatic adjustment of the rounding height.
- **discharge** of the dough pieces: after each turn of the dividing drum the dough pieces are discharged from the piston cylinders by means of dividing pistons and are transferred to the following spreading finger belt with the required seam position.

## REX AUTOMAT FUTURA - *the extremely versatile machine*

The most important feature of this machine is its enlarged dividing drum with 8 rows of dividing cylinders located around the outside of the dividing drum and equipped with dividing pistons of different shapes and sizes.

**Switching between the two dividing pistons occurs electromechanically by pressing a button and does not interrupt the operation.**

The double chamber principle offers the following advantages:

- considerable extension of the weight range
- possibility of so-called "RUSTIKA" pistons for the production of angular, country-style bread rolls
- possibility of special pistons, e.g. for American Cookies

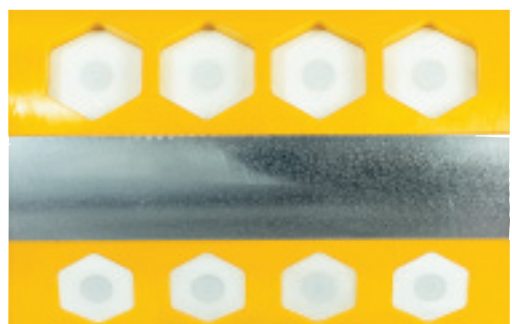
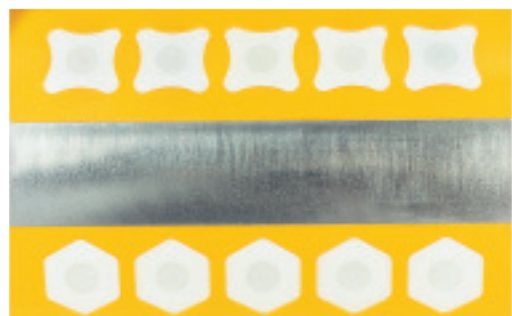

# REX AUTOMAT CLASSIC II

## Weight range

## Execution

Size	g	6000 pieces 4 rows	7500 pieces 5 rows	9000 pieces 6 rows
00	20-50			
0	22-55			
1	35-85			
2-0	50-110			
2	55-125			
2-1	60-135			
3	65-160			

This table only includes the most common models. The weight ranges depend on the dough feed and consistency and may therefore increase or decrease. INDIVIDUAL special weight ranges upon request.

## REX AUTOMAT FUTURA Examples

Model	Rows	Weight range (depending on dough)	Piston size (for rounding)	RUSTIKA-piston (for dividing)	Hourly capacity
Futura	4	35 - 125 g	SK58 + SK67		6000 pcs.
T4 S-	4	35 - 85 g	SK58	59 or 61 or 64 mm	6000 pcs.
MKB	4	55 - 125 g	SK67	59 or 61 or 64 mm	6000 pcs.
Futura	5	35 - 125 g	SK58 + SK67		7500 pcs.
T5 S-	5	35 - 85 g	SK58	59 or 61 or 64 mm	7500 pcs.
MKB	5	55 - 125 g	SK67	59 or 61 or 64 mm	7500 pcs.
Futura	6	35 - 85 g	SK68	55 or 59 or 61 mm	9000 pcs.
T6 S-					
MKB					

## Special equipment for all requirements

### Dough discharge roller or turning flap

We supply the following devices for an exact transfer of the dough pieces from the dividing drum to the following spreading finger belt:

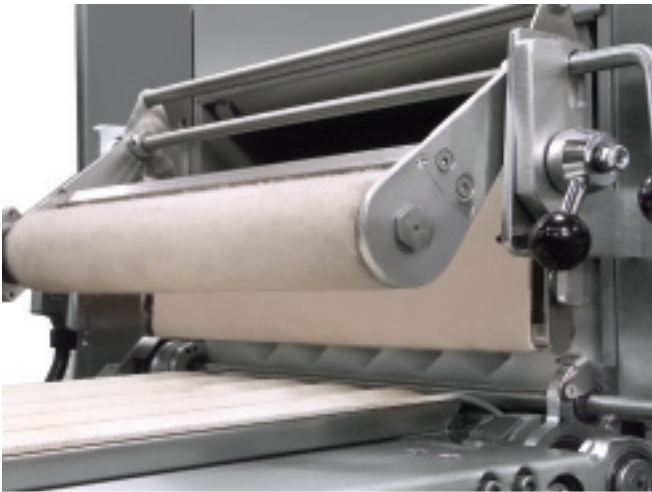

Liftable dough discharge roller for transfer with seam down



Adjustable turning flap for transfer with seam up

### Hopper with infeed rollers

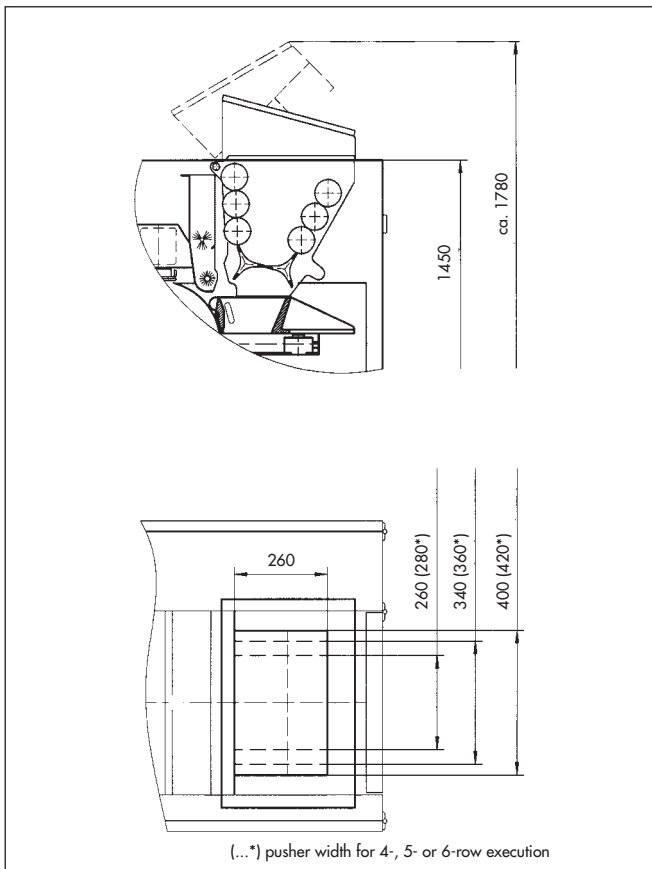

Dough capacity: approx. 17,23 or 28 litres for 4-, 5- or 6-row execution of the REX

**The hopper with infeed rollers is a precondition for the connection of a large dough hopper.**

## Large dough hoppers TRÖ 160 and TRÖ 240

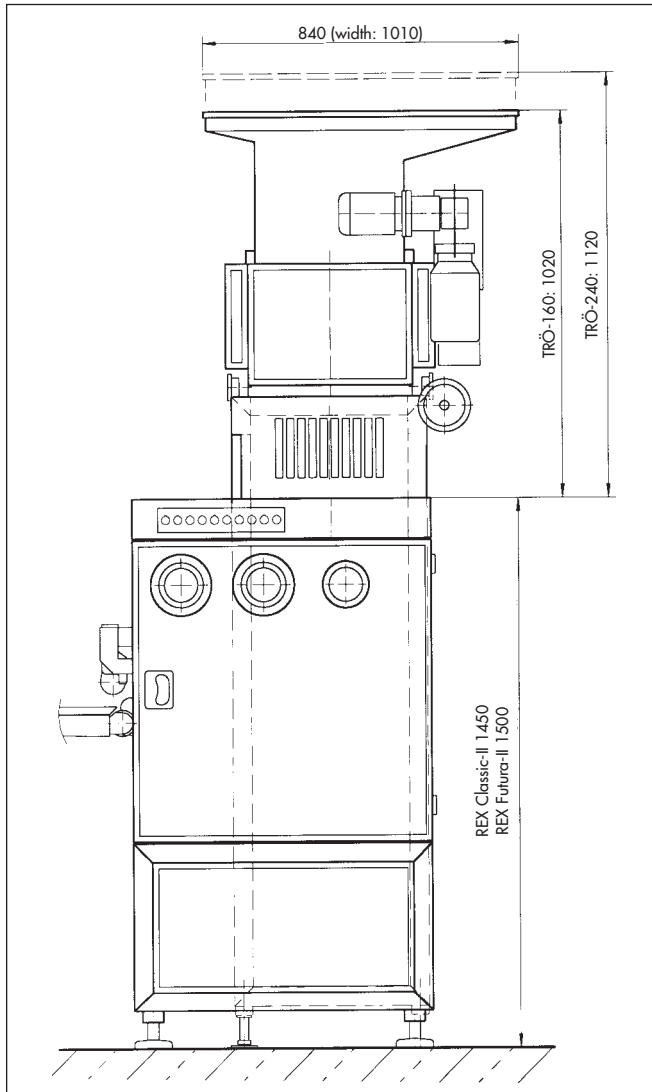

For easier cleaning or manual feeding the large dough hoppers TRÖ 160 and TRÖ 240 can be removed from the hopper with infeed rollers located underneath using a threaded spindle.



Dough capacity: 160 resp. 240 litres  
Special sizes up to 400 litres on request

## Standard control



Clear and simple operation of the "STANDARD" execution. Dough weight and rounding speed adjustment as well as rounding height fine adjustment are carried out manually. The rounding time can be adjusted to different dough consistencies by means of a potentiometer.

## Logical menu-driven "B-Tronic" PLC control

Standard for Rex Automat Futura,  
Option for Rex Automat Classic



### B-Tronic computer control

Dough weight, rounding speed, rounding pressure and flour quantity are adjusted electromechanically. These adjustments can be stored as a programme with the other machine parameters.

The Siemens Blue line touch-panel enables easy input. The B-Tronic is fitted with an adjustable automatic piston lifting device.

Further features:

- storage of 30 programmes
- visual display of all machine parameters
- pre-selection of number of dough pieces
- display of maintenance interval

## Spreading finger belt duster

Also available with pressure roller.  
Duster inserts can be removed and changed.

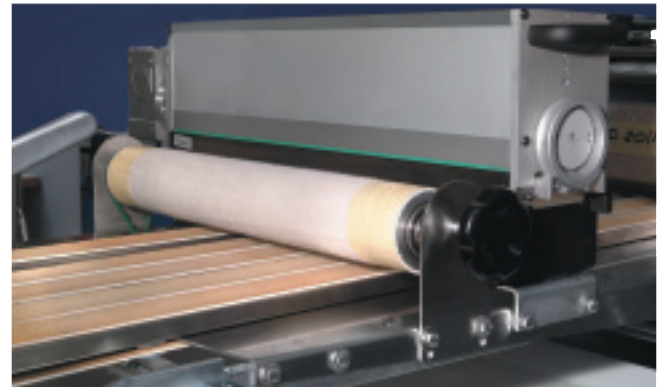

## Row reduction

When using the Rex Automat as a head machine for a roll plant, it can be supplied with row reduction to suit the forming station and thereby different shapes and sizes of various bread rolls.

The number of rows is changed by exchanging the dough pusher, inserting suitable segments to cover the rows of the dividing drum and adopting the opening of the dough hopper by means of adjustable guide plates- **simple to do in only a few minutes**

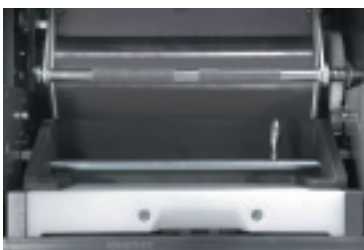

Reduction from e.g. 5...

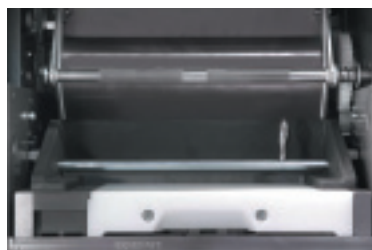

...to 4 rows

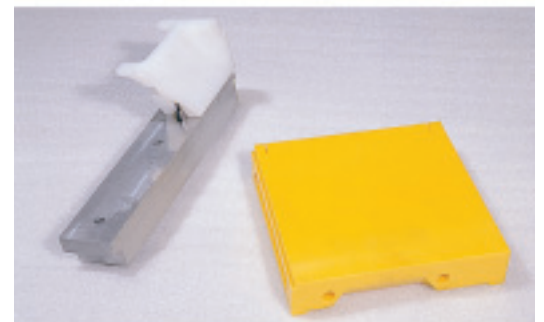

Exchangeable parts for row reduction

## Cleaning and maintenance

### Cleaning:

The Rex features big doors for excellent access while cleaning. Thus, it is possible to keep the machine clean with a minimum of effort. When the dough hopper is lifted all parts inside the dividing area are accessible. All parts in contact with dough are either coated with a wear and dough resistant material or made of high-quality synthetic material. All materials comply with the food regulation **FDA Class H1**. The dividing drum has a hard coat as standard and the base plate is chemically nickel-coated. The cam control slides in the dividing drum are continuously sealed in an oil bath.



The hopper duster with portioning brush and following distribution brush with adjustable drive for better dusting results in the dividing area; the brushes can be pulled out for easy cleaning.

### Maintenance:

The Rex Automat is maintenance free to a large extent. Maintenance is limited to lubricating the chains and checking the oil level.

The use of standardised, globally available industrial components guarantees fail-safe operation.



## Rex Automat as head machine for prover plants

The Rex Automat can also be connected to provers not produced by KÖNIG.

The synchronisation unit is built in.

The prover determines the speed of the line and the Rex Automat adjusts its speed automatically to suit the prover.



KÖNIG ECO 4000 NGS plant with final prover N20

Presented by:



**KÖNIG Maschinen** Gesellschaft m.b.H.  
Stattegger Strasse 80, A-8045 Graz-Andritz  
Tel.: +43/316/6901-0, Fax: +43/316/6901-115  
e-mail: [info@koenig.co.at](mailto:info@koenig.co.at), <http://www.koenig.co.at>

Dimensions in mm - **not binding**.  
Technical changes reserved.