

SPECIFICATIONS

Model	Bag Width	Bag Length	Max. Speed
SB-3600	3 1/2" to 8"	5 1/2" to 11"	60 per min
SB-7200	3 1/2" to 4 1/2"	5 1/2" to 11"	120 per min
SB-1200	6" to 12 1/2"	8" to 19"	20 per min

DIMENSIONS

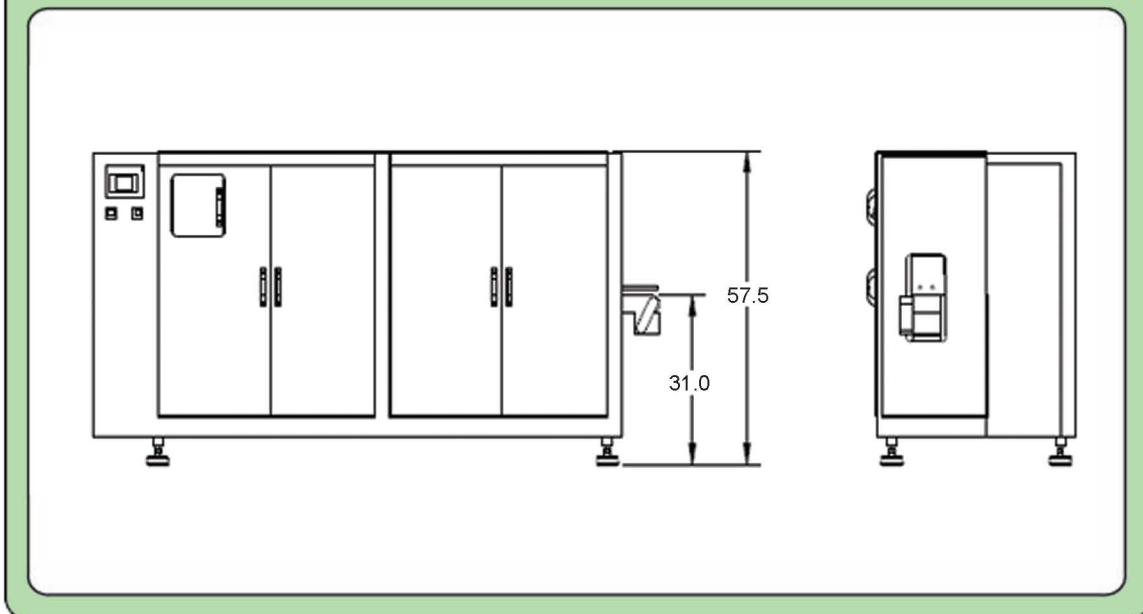

AVAILABLE OPTIONS

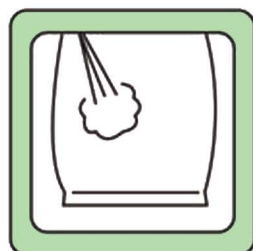

Gas Flush

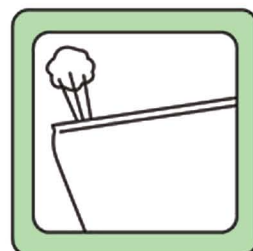

Bag Deflating Mechanism

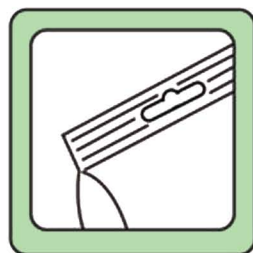

Hole Punching

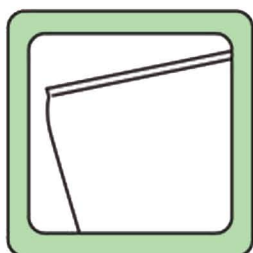

Code Dating

The **Swifty Bagger** is the most efficient way to bag a wide variety of products in pre-made stand-up or zippered pouches.

Package: Liquids, sauces, frozen foods, dairy, snacks, candy, pet food, pharmaceuticals, chemicals, powders, granulars and more...

The **Swifty Bagger** automatically takes the bag from the delivery station, positions the bag, unlocks the zipper (if applicable), and then blows open the bag to fill it.

Interface ready for most types of fillers, it spreads the bag to eliminate creases then seals it before being carried out upright by the conveyor.

SWIFTYBAGGER

Horizontal Pouch Bagger



WEIGHPACK

Las Vegas **Miami** Chicago **Montreal** Shanghai

1.888.934.4472

info@weighpack.com www.weighpack.com

WEIGHPACK
SYSTEMS INC.

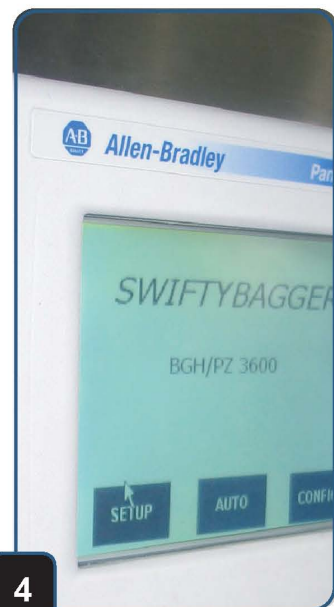
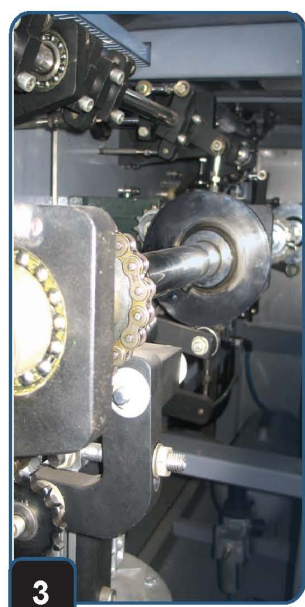
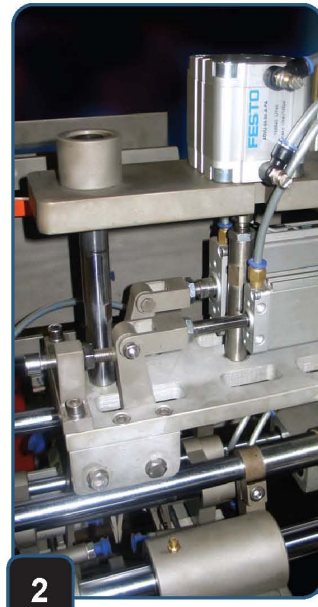

1. Adjustable Bag Width and Length
2. Positive Bag Clamp Mechanism
3. Heavy Duty Mechanical Cam Drive
4. Allen-Bradley PLC Touch Screen
5. Variable Speed Control
6. Integrated Exit Conveyor
7. Stainless Steel, Quality Construction
8. Wicketless Pouches, Pillow or Stand-Up Bags

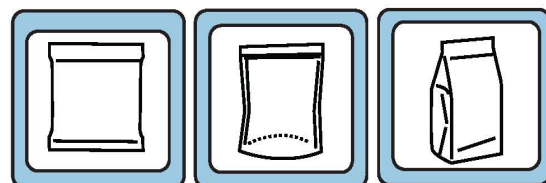

SWIFTYBAGGER

Intermittent Motion Horizontal Pouch Bagger

Make the **Swiftly Bagger** part of your fully automated WeighPack weighing & packaging system.

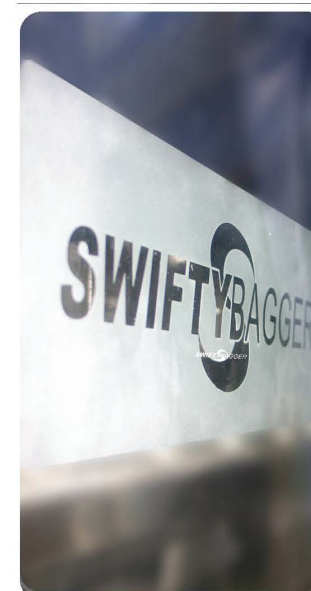

The **Swiftly Bagger** is an automatic solution for opening, filling and sealing of pouch, pillow or stand-up style bags with or without zipper closure. The **Swiftly Bagger** uses pre-made bags of various materials, including laminates, polyethylene and metallized type bags.

The affordable **Swiftly Bagger** is easy to use, easy to clean and has a speedy changeover time, thus increasing production flexibility and productivity. So versatile that it is perfect for liquids, powders granulars and frozen or fresh products alike.

The **Swiftly Bagger** horizontal bagger is designed for ease of use. The flat color touch screen control panel offers an intuitive user interface that is easy to learn and easy to use.

Combine the **Swiftly Bagger** with any one of our filling machines for a fast, flexible productive system.