

OPERATOR MANUAL

IMPORTANT INFORMATION, KEEP FOR OPERATOR

This manual provides information for:

DOMESTIC MODELS:

DEE-4T - 40/60(C,A) INA/2

DHT - 40/60(C,A) INA/2

D(L) - 40/60/80 INA/2

- Electric, Gas or Steam Heated
- Floor Mounted
- Tilting Kettle
- Tilt Out Agitator Drive System
- Variable Speed Agitator Controls
- Inclined Agitator



THIS MANUAL MUST BE RETAINED FOR FUTURE REFERENCE. READ, UNDERSTAND AND FOLLOW THE INSTRUCTIONS AND WARNINGS CONTAINED IN THIS MANUAL.

FOR YOUR SAFETY

Do not store or use gasoline or other flammable vapors and liquids in the vicinity of this or any other appliance.

WARNING

Improper installation, adjustment, alteration, service or maintenance can cause property damage, injury or death. Read the installation, operating and maintenance instructions thoroughly before installing or servicing this equipment.

NOTIFY CARRIER OF DAMAGE AT ONCE

It is the responsibility of the consignee to inspect the container upon receipt of same and to determine the possibility of any damage, including concealed damage. Unified Brands suggests that if you are suspicious of damage to make a notation on the delivery receipt. It will be the responsibility of the consignee to file a claim with the carrier. We recommend that you do so at once.

Manufacture Service/Questions 888-994-7636.

Information contained in this document is known to be current and accurate at the time of printing/creation. Unified Brands recommends referencing our product line websites, unifiedbrands.net, for the most updated product information and specifications.

PART NUMBER 176706, REV. B (11/18)

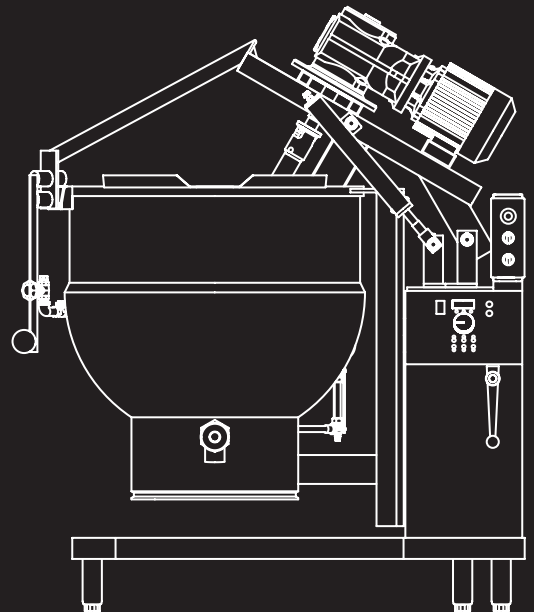

1055 Mendell Davis Drive
Jackson, MS 39272
888-994-7636, fax 888-864-7636
unifiedbrands.net

IMPORTANT - READ FIRST - IMPORTANT

- CAUTION:** BE SURE ALL OPERATORS READ, UNDERSTAND AND FOLLOW THE OPERATING INSTRUCTIONS, CAUTIONS, AND SAFETY INSTRUCTIONS CONTAINED IN THIS MANUAL.
- WARNING:** THIS UNIT IS INTENDED FOR USE IN THE COMMERCIAL HEATING, COOKING AND HOLDING OF WATER AND FOOD PRODUCTS, PER THE INSTRUCTIONS CONTAINED IN THIS MANUAL. ANY OTHER USE COULD RESULT IN SERIOUS PERSONAL INJURY OR DAMAGE TO THE EQUIPMENT.
- WARNING:** THE KETTLE MUST BE INSTALLED BY PERSONNEL QUALIFIED TO WORK WITH ELECTRICITY. IMPROPER INSTALLATION CAN RESULT IN INJURY TO PERSONNEL AND/OR DAMAGE TO EQUIPMENT.
- DANGER:** ELECTRICALLY GROUND THE UNIT AT THE TERMINAL PROVIDED. FAILURE TO GROUND UNIT COULD RESULT IN ELECTROCUTION AND DEATH.
- WARNING:** AVOID ALL DIRECT CONTACT WITH HOT EQUIPMENT SURFACES. DIRECT SKIN CONTACT COULD RESULT IN SEVERE BURNS.
- WARNING:** AVOID ALL DIRECT CONTACT WITH HOT FOOD OR WATER IN THE KETTLE. DIRECT CONTACT COULD RESULT IN SEVERE BURNS.
- CAUTION:** DO NOT OVER FILL THE KETTLE WHEN COOKING, HOLDING OR CLEANING. KEEP LIQUIDS A MINIMUM OF 2-3" (5-8 CM) BELOW THE KETTLE BODY RIM TO ALLOW CLEARANCE FOR STIRRING, BOILING AND SAFE PRODUCT TRANSFER.
- WARNING:** TAKE SPECIAL CARE TO AVOID CONTACT WITH HOT KETTLE BODY OR HOT PRODUCT WHEN ADDING INGREDIENTS, STIRRING OR TRANSFERRING PRODUCT TO ANOTHER CONTAINER.
- WARNING:** DO NOT STAND ON OR APPLY UNNECESSARY WEIGHT OR PRESSURE ON THE KETTLE FRONT OR POURING LIP. THIS COULD RESULT IN OVERLOAD AND FAILURE OF THE TILT MECHANISM, AND POSSIBLE SERIOUS INJURY AND BURNS TO THE OPERATOR AND OTHERS.
- WARNING:** WHEN TILTING KETTLE FOR PRODUCT TRANSFER:
- 1) WEAR PROTECTIVE OVEN MITT AND PROTECTIVE APRON.
 - 2) USE CONTAINER DEEP ENOUGH TO CONTAIN AND MINIMIZE PRODUCT SPLASHING.
 - 3) PLACE CONTAINER ON STABLE, FLAT SURFACE, AS CLOSE TO KETTLE AS POSSIBLE.
 - 4) STAND TO LEFT OR RIGHT SIDE OF KETTLE WHILE POURING. DO NOT STAND DIRECTLY IN POUR PATH OF HOT CONTENTS.
 - 5) POUR SLOWLY, MAINTAIN CONTROL OF KETTLE, AND RETURN KETTLE BODY TO UPRIGHT POSITION AFTER CONTAINER IS FILLED OR TRANSFER IS COMPLETE.
 - 6) DO NOT OVER-FILL CONTAINER. AVOID DIRECT SKIN CONTACT WITH HOT CONTAINER AND ITS CONTENTS.
- CAUTION:** KEEP FLOORS IN FRONT OF KETTLE WORK AREA CLEAN AND DRY. IF SPILLS OCCUR, CLEAN IMMEDIATELY, TO AVOID SLIPS OR FALLS.
- WARNING:** FAILURE TO CHECK PRESSURE RELIEF VALVE OPERATION PERIODICALLY COULD RESULT IN PERSONAL INJURY AND/OR DAMAGE TO EQUIPMENT.
- WARNING:** WHEN TESTING, AVOID ANY EXPOSURE TO THE STEAM BLOWING OUT OF THE PRESSURE RELIEF VALVE. DIRECT CONTACT COULD RESULT IN SEVERE BURNS.
- WARNING:** TO AVOID INJURY, READ AND FOLLOW ALL PRECAUTIONS STATED ON THE LABEL OF THE WATER TREATMENT COMPOUND.
- WARNING:** BEFORE REPLACING ANY PARTS, DISCONNECT THE UNIT FROM THE ELECTRIC POWER SUPPLY.
- WARNING:** TURN OFF POWER AT THE CIRCUIT BREAKER PRIOR TO INSTALLATION OR SERVICE.

IMPORTANT - READ FIRST - IMPORTANT

- WARNING:** THE MIXER MUST BE INSTALLED BY PERSONNEL WHO ARE QUALIFIED TO WORK WITH ELECTRICITY, IMPROPER INSTALLATION CAN RESULT IN INJURY TO PERSONNEL AND/OR DAMAGE TO EQUIPMENT.
- WARNING:** ANY MECHANICAL OR ELECTRICAL CHANGE MUST BE APPROVED BY THE GROEN FOOD SERVICE ENGINEERING DEPARTMENT.
- WARNING:** TURN OFF AGITATOR BEFORE ADDING INGREDIENTS OR INSPECTING KETTLE CONTENTS. DO NOT WEAR LOOSE CLOTHING OR JEWELRY AROUND OPERATING MIXER KETTLE. KEEP WELL CLEAR OF ROTATING MIXER ARMS AND PADDLES AT ALL TIMES.
- WARNING:** THE UNIT IS EQUIPPED WITH AN AUTOMATIC CUTOFF SWITCH. IF POWER IS ON WHEN A TILTED MIXER IS LOWERED INTO THE OPERATING POSITION, THE MIXER WILL AUTOMATICALLY START.
- CAUTION:** STARTING WITH THE MIXER SET AT HIGH SPEED MAY CAUSE MATERIAL TO SPILL OUT OF THE KETTLE ON TWO SPEED AND VARIABLE SPEED UNITS.
- CAUTION:** UNDER HEAVY LOAD DO NOT RUN THE MIXER CONTINUOUSLY AT SLOWER THAN 5% OF FULL SPEED. SLOWER OPERATION COULD DAMAGE THE SPEED CONTROL.
- WARNING:** BEFORE CLEANING ANY PART OF THE MIXER, OTHER THAN THE AGITATOR, DISCONNECT THE ELECTRICAL SUPPLY AT THE CIRCUIT BREAKER OR FUSE BOX TO AVOID POSSIBLE ELECTRICAL SHOCK.
- WARNING:** KEEP WATER AND SOLUTIONS OUT OF THE CONTROLS, ELECTRICAL WIRING, AND DRIVE MECHANISM. NEVER SPRAY OR HOSE THE MIXER.
- CAUTION:** WHEN YOU INSTALL THE SCRAPER BLADES, MAKE SURE THE SCRAPER IS CURVED. A REVERSED SCRAPER WILL NOT SCRAPE AND CAN CAUSE SERIOUS DAMAGE.
- WARNING:** AVOID CONTACT WITH CLEANING PRODUCTS IN ACCORDANCE WITH SUPPLIER AND MANUFACTURER RECOMMENDATIONS. MANY CLEANERS ARE HARMFUL TO THE SKIN, EYES, MUCOUS MEMBRANES AND CLOTHING. READ THE WARNINGS AND FOLLOW DIRECTIONS ON THE CLEANER LABEL.
- WARNING:** USE OF ANY REPLACEMENT PARTS OTHER THAN THOSE SUPPLIED BY GROEN OR THEIR AUTHORIZED DISTRIBUTOR VOIDS ALL WARRANTIES AND CAN CAUSE BODILY INJURY TO THE OPERATOR AND DAMAGE TO THE EQUIPMENT.
- WARNING:** SERVICE PERFORMED BY OTHER THAN FACTORY AUTHORIZED PERSONNEL WILL VOID ALL WARRANTIES.
- WARNING:** BEFORE REPLACING ANY PARTS, SHUT OFF ALL ELECTRIC POWER SUPPLIES TO THE COOKER/ MIXER.
- WARNING:** USE ONLY GROEN-SUPPLIED PARTS. SUBSTITUTION OF UNAUTHORIZED OR GENERIC PARTS CAN RESULT IN BODILY INJURY TO THE OPERATOR AND DAMAGE TO THE EQUIPMENT.
- WARNING:** DO NOT PLACE HANDS, TOOLS, OR HOSES IN KETTLE WHILE AGITATOR IS MOVING.
- WARNING:** AGITATOR AREA MUST BE CLEAR OF OBSTRUCTION BEFORE OPERATION. TO RUN AGITATOR:
- 1) ENSURE KETTLE IS FULLY UPRIGHT
 - 2) ENSURE MIXER HEAD IS FULLY DOWN AND LATCHED
 - 3) SET THE SPEED DIAL TO DESIRED SPEED
 - 4) TURN THE START SWITCH TO ON
- TO STOP AGITATOR:
- 1) PRESS THE RED STOP BUTTON OR TURN THE SWITCH TO OFF

Table of Contents

Important Operator Warnings	page 2-3
References.....	page 4
Equipment Description.....	page 5
Installation	page 5
Initial Start-Up.....	page 6
Agitator Operation	page 6
Operation	page 7
Cleaning.....	page 8-9
Maintenance.....	page 9
Troubleshooting.....	page 10
Parts List	page 11-13
Service Log	page 14

References

NATIONAL FIRE PROTECTION ASSOCIATION
60 Battery March Park
Quincy, Massachusetts 02269

NFPA/70 - The National Electrical Code

Equipment Description

The Groen INA/2 assembly is an electrically powered mixer with an inclined agitator, which is incorporated into Groen kettles of 40 to 80 gallon capacity. The patented design provides a gentle lifting and folding action which avoids the build-up of heavy particles at the bottom of the kettle. This action is uniquely efficient in preparing such products as stews, ground meat, pie fillings, franks and beans, and similar items.

The agitator frame is constructed of tubular stainless steel and fitted with shovel-type scrapers. It is easily removed for cleaning. The mixer has a variable speed drive with electrical speed control.

For a description of the kettle component of your cooker/mixer, see the separate kettle manual.

Installation

WARNING
TURN OFF POWER AT THE CIRCUIT
BREAKER PRIOR TO INSTALLATION.

**THE MIXER MUST BE INSTALLED BY
PERSONNEL WHO ARE QUALIFIED TO
WORK WITH ELECTRICITY. IMPROPER
INSTALLATION CAN RESULT IN INJURY
TO PERSONNEL AND/OR DAMAGE TO
EQUIPMENT.**

**ANY MECHANICAL OR ELECTRICAL
CHANGE MUST BE APPROVED BY THE
GROEN FOOD SERVICE ENGINEERING
DEPARTMENT.**

WARNING
TO PREVENT POSSIBLE ELECTRIC
SHOCK, GROUND THE UNIT AT THE
TERMINAL PROVIDED.



Your Groen mixer has been test operated at the factory and is furnished with all internal wiring. It is complete and ready for final connection. A wiring diagram is furnished at the rear of this manual. Installation is as follows:

1. Set the cooker/mixer in place and level it. If the mixer is a tilting model, confirm that there is enough rear or side clearance, depending on model, and overhead clearance to tilt the mixer safely through its entire tilting range. Provide enough clearance to permit access for service as well. Fasten the cooker/mixer to the floor or deck to reduce chances that the unit could tip over if unit is provided with flanged feet.
2. Provide the proper electric power supply as specified on the electrical information plate attached to the mixer. Observe local codes and/or The National Electrical Code in accordance with ANSI/NFPA 70 - latest edition. The installation must conform to the code that has the more strict requirements.
3. Your mixer requires a permanent connection with the electrical service. Use waterproof conduit and waterproof connectors for this connection.
4. Any electrical service for the kettle will require a separate connection. See the specific kettle manual.
5. Use the following check list to confirm that the installation is correct.
 - Unit level
 - Adequate clearance for tilting
 - Access for service
 - Unit fastened down
 - Mixer power supply conforms to information plate and code
 - Electrical conduit and connections are waterproof
 - Mixer grounded

For instructions on installing the kettle component of your cooker/mixer, see the separate kettle manual.

Initial Start-Up

WARNING
TURN OFF AGITATOR BEFORE ADDING INGREDIENTS OR INSPECTING KETTLE CONTENTS. DO NOT WEAR LOOSE CLOTHING OR JEWELRY AROUND OPERATING MIXER KETTLE. KEEP WELL CLEAR OF ROTATING MIXER ARMS AND PADDLES AT ALL TIMES.

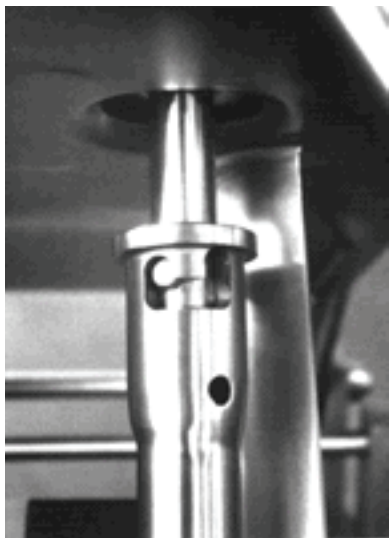

Slip-On Coupling

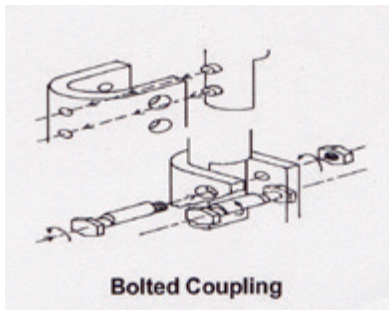

Bolted Coupling

Kettles with 100 Gallon capacity and larger

After the mixer is installed, take the following actions to confirm that the equipment is operating correctly.

1. Tilt the mixer through its complete tilting range to ensure that there is no hazard or interference.
2. Make sure the agitator is properly coupled with its drive shaft. If the mixer has a slip-on coupling, the drive pin must be positioned at the end of the J-slot. If a bolted coupling is employed, the bolts must be turned to the proper position and the nuts must be tightened.
3. When the mixer is in operating position, every scraper blade should touch the inside of the kettle during at least part of each revolution of the agitator.
4. At the circuit breaker or fuse box, turn on the electric power supply to the mixer.
5. Switch on the drive and confirm that the mixer operates smoothly. For a variable speed model, confirm that the mixer operates correctly throughout its speed range.
6. Make sure the agitator turns in the correct direction, so it pushes the nylon scraper blades ahead of the agitator bar.

If the unit functions as described above, it is ready for use. If the unit does not function as intended, call your local Groen authorized service agency.

For instructions on initial start-up of the kettle component of your cooker/mixer, see the separate kettle manual.

Agitator Operation

WARNING
DO NOT PLACE HANDS, TOOLS, OR HOSES IN KETTLE WHILE AGITATOR IS MOVING. AGITATOR AREA MUST BE CLEAR OF OBSTRUCTION BEFORE OPERATION.

TO RUN AGITATOR

1. Ensure kettle is fully upright.
2. Ensure mixer head is fully down and latched.
3. Set the speed dial to desired speed.
4. Turn the start switch to ON.

TO STOP AGITATOR

1. Press the red STOP button or turn the ON/OFF toggle switch to OFF.

Operation

WARNING
TURN OFF AGITATOR BEFORE ADDING INGREDIENTS OR INSPECTING KETTLE CONTENTS. DO NOT WEAR LOOSE CLOTHING OR JEWELRY AROUND OPERATING MIXER KETTLE. KEEP WELL CLEAR OF ROTATING MIXER ARMS AND PADDLES AT ALL TIMES.

WARNING
THE UNIT IS EQUIPPED WITH AN AUTOMATIC TILT CUTOFF SWITCH. IF POWER IS ON WHEN A TILTED MIXER IS LOWERED INTO OPERATING POSITION, THE MIXER CAN AUTOMATICALLY START.

CAUTION
STARTING WITH THE MIXER SET AT HIGH SPEED MAY CAUSE MATERIAL TO SPILL OUT OF THE KETTLE ON VARIABLE SPEED UNITS.

CAUTION
UNDER HEAVY LOAD DO NOT RUN THE MIXER CONTINUOUSLY AT SLOWER THAN 5% OF FULL SPEED. SLOWER OPERATION COULD DAMAGE THE SPEED CONTROL.

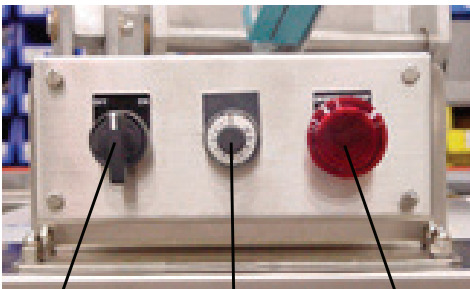

ON/OFF Switch

Mixer Speed Control Knob

Emergency Stop Switch

1. Before you operate the mixer, make sure that the agitator is firmly connected with the drive shaft and properly positioned in the kettle. The agitator must be positioned so every scraper blade touches the kettle during at least part of each revolution. To connect the agitator:

Slip-on Coupling: Slide the coupling up onto the shaft as far as it will go. Then turn the agitator and pull it down, so that the drive pin on the shaft becomes firmly seated against the end of the J-slot.

Bolted Coupling:

- a. Guide the two pins of the drive shaft into the holes in the coupling.
 - b. With the lobe of the cam pointing up, and while holding the two cam bolts, insert the bolts through the larger holes in the side of the coupling. The bolts must pass the flat part of the shaft, and through the smaller holes in the other side of the coupling.
 - c. Turn the cam bolts toward the shaft 1/8 turn or until the lobe of the cam is snug against the flat side of the shaft.
 - d. Fasten the bolts in place with the supplied hex nuts, and tighten the nuts.
2. If the mixer has been tilted up, lower it into operating position.
 3. Turn on electric power to the unit at the circuit breaker or fuse box.
 4. Switch on the drive.
 5. Set the desired mixing speed. On a variable speed drive with electrical speed control, turn the speed adjustment knob.
 6. To stop the mixer, switch off the drive. If the cooker/mixer will be cleaned or serviced, or will not be used for a week or longer, cut off all power supplies to the unit at the circuit breaker or fuse box.
 7. Switch off the drive, before you tilt the mixer. To tilt the mixer, first unlatch it. For some units, you may need to tilt the kettle forward slightly to let the agitator clear the kettle wall as you tilt the mixer.
 8. As you tilt the mixer out of the kettle, clean any clinging product from the agitator, so product will not drip onto the outside of the kettle or surroundings, and so the weight of product will not make the mixer fall down.

To operate the kettle component of your cooker/mixer, see the separate kettle manual.

Cleaning

WARNING
BEFORE CLEANING ANY PART OF THE MIXER, OTHER THAN THE AGITATOR, SHUT OFF ALL ELECTRIC POWER TO THE COOKER/MIXER AT THE CIRCUIT BREAKER OR FUSE BOX, TO AVOID POSSIBLE ELECTRIC SHOCK. KEEP WATER AND SOLUTIONS OUT OF THE CONTROLS, ELECTRICAL WIRING, AND DRIVE MECHANISM. NEVER SPRAY OR HOSE THE MIXER.

WARNING
AVOID CONTACT WITH ANY CLEANER, AS RECOMMENDED BY THE SUPPLIER. CAREFULLY READ THE WARNINGS AND FOLLOW THE DIRECTIONS ON THE LABEL OF THE CLEANER. MANY CLEANERS ARE HARMFUL TO THE SKIN, EYES, MUCOUS MEMBRANES, AND CLOTHING.

CAUTION
NEVER LEAVE A SANITIZER IN CONTACT WITH THE SURFACE OF STAINLESS STEEL LONGER THAN 20 MINUTES. LONGER CONTACT CAN CAUSE CORROSION.

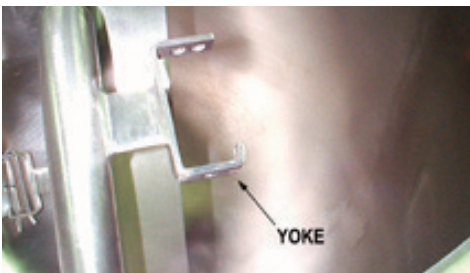

1. Suggested Cleaning Supplies:

- A good stainless steel cleaner.
- Stiff brushes in good condition.
- Sanitizer solution.

2. Precautions

Before any cleaning operation, shut off the cooker/mixer by turning the thermostat dial to "OFF", and shut off all electric power to the unit at a remote switch, such as the circuit breaker. See warning at left.

3. Procedure

- Wash the agitator as soon as possible after use. If the unit is in continuous use, thoroughly clean and sanitize all parts of the mixer at least once every 12 hours.
- Disassemble the scrapers and clean them along with the rest of the agitator, then reassemble them.

To disassemble a scraper:

- Pull the hairpin clip out of the yoke. To make this easier, squeeze the ends of the clip closer together. (See Photos).
- Remove the locking clip, then pull the plastic scraper blade out of its holder.



To reassemble a scraper:

- Push the blade as far as it will go into the holder.
 - From the back or convex side of the holder (the side that will be facing the kettle wall), hook the locking clip through the slot in the blade. Position the loop of the locking clip, so the hairpin clip will pass through it.
 - Position the scraper in the yoke, then insert the hairpin clip. Squeeze the ends of the clip closer together to help them pass through the second side of the yoke. Make sure the hairpin clip has passed through the loop of the locking clip.
- Prepare a hot solution of the cleaning compound as instructed by the supplier. Wash the agitator parts and rinse them well. Use a cloth moistened with the cleaning solution to clean other parts of the mixer.
 - To remove materials stuck to the agitator, use a brush, sponge, cloth, plastic or rubber scraper, or plastic wool along with the cleaning solution. To make washing easier, let the cleaning solution soak into the residue. When you clean the stainless steel parts, do not use any abrasive material (like metal sponges or scouring powder) or metal implement (like a spoon, scraper, or wire brush) that might scratch the surface. Scratches make the surface hard to clean and provide places for bacteria to grow. Do not use steel wool, which may leave particles imbedded in the surface and cause eventual corrosion and pitting.
 - As part of the daily cleaning program, clean all surfaces that may have been soiled. Remember to check such parts as the back and underside of the drive housing.

Cleaning

- f. When the agitator needs to be sanitized, use a sanitizing solution equivalent to one that supplies 100 parts per million available chlorine. Obtain advice on the best sanitizing agent from your supplier of sanitation products. Following the supplier's directions, apply the sanitizer after the agitator has been washed, then rinse off the sanitizer completely. It is recommended that the agitator be sanitized just before use.
- g. The exterior of the unit may be polished with a good quality stainless steel cleaner.

Cleaning procedures for the kettle component of your cooker/mixer are described in the separate kettle manual.

Maintenance

WARNING
USE OF ANY REPLACEMENT PARTS OTHER THAN THOSE SUPPLIED BY GROEN OR THEIR AUTHORIZED DISTRIBUTOR VOIDS ALL WARRANTIES AND CAN CAUSE BODILY INJURY TO THE OPERATOR AND DAMAGE TO THE EQUIPMENT.

WARNING
BEFORE REPLACING ANY PARTS, SHUT OFF ALL ELECTRIC POWER SUPPLIES TO THE COOKER/MIXER.

1. Periodic Service

- a. The interior of control and drive housings should be kept clean and dry.
- b. Electrical wiring should be kept securely connected and in good condition.
- c. Regular service of the mixer should include cleaning the motor and checking the reducer gearcase. Check oil level at 3000 hrs of operation or every 6 months. Change oil completely every 3 years or 15,000 hrs. Lubricant type is "GG Arctic SHC 23". Food grade lubricant (Mobil product).

2. Component Replacement

All internal wiring is marked as shown on the schematic drawings in this manual. Be sure that new components are wired in the same manner as the old components.

3. Service Records

A Service Log is provided at the rear of this manual. Each time service is performed on this equipment, enter the date on which the work was done, what was done, and who did it. Keep this log with the equipment.

Service procedures for the kettle component of the cooker/mixer are described in the separate kettle manual.

Troubleshooting

Your unit is designed to operate smoothly and efficiently if properly maintained. However, the following is a list of checks to make in the event of a problem. Wiring diagrams are furnished inside the service panel. X indicates items which must be performed by an authorized technician. **USE OF ANY REPLACEMENT PARTS OTHER THAN THOSE SUPPLIED BY UNIFIED BRANDS OR THEIR AUTHORIZED DISTRIBUTORS CAN CAUSE INJURY TO THE OPERATOR AND DAMAGE TO THE EQUIPMENT AND WILL VOID ALL WARRANTIES.**

SYMPTOM	WHO	WHAT TO CHECK
Motor will not run.	User	a. Power supply to the unit. b. For a mechanical overload. (example: frozen product) c. Circuit breaker or fuse.
	Authorized Service Rep Only	d. That the tilt switch is closed. X e. For a ground or short in the motor. X f. Overload heaters. X
Motor runs slowly.	User	a. For a mechanical overload.
	Authorized Service Rep Only	b. For open motor field circuit, by checking field current. X
Motor speed varies rapidly.	User	a. For an oscillating load, by disconnecting the mixer drive from the agitator and checking motor speed.
	Authorized Service Rep Only	b. Variable speed controller. X
Motor overheats and/or sparks excessively.	User	a. For a mechanical overload. b. Ambient temperature is high.
	Authorized Service Rep Only	c. Incorrect supply voltage to motor. X d. Excessive variation (under voltage or over voltage) in supply voltage. X e. Single phasing due to loose connection in supply line or a blow fuse. X
Circuit breaker or heater cuts out frequently.	User	a. For a mechanical overload.
	Authorized Service Rep Only	b. Whether line voltage is too high. X c. Motor armature and wiring for ground or short. X d. For open motor field circuit, by checking field current. X e. For defective circuit breaker. X f. Motor is improperly connected. X

Troubleshooting guidance for the kettle component of your cooker/mixer is contained in the separate kettle manual.

Parts List

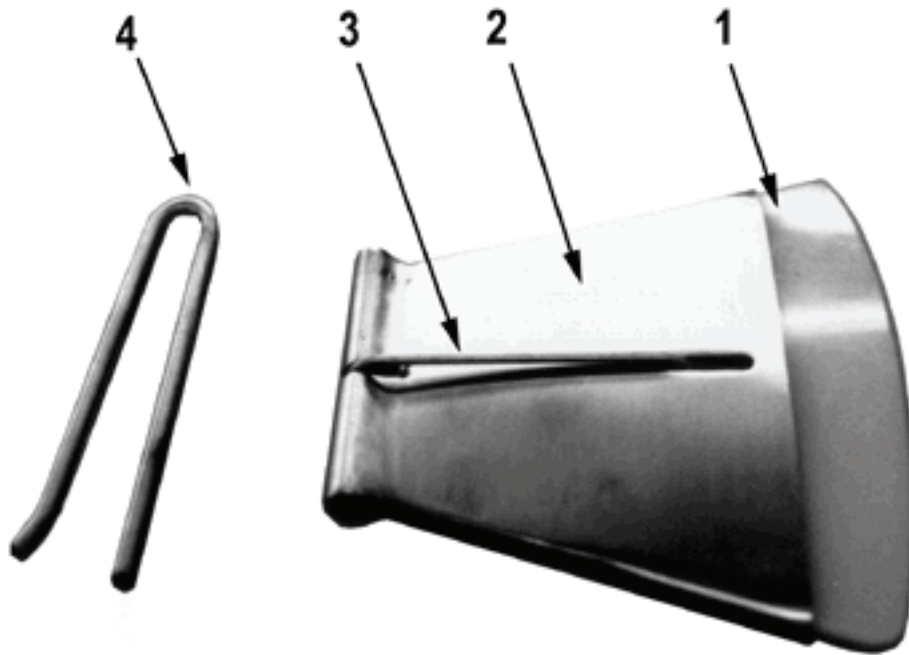

Ref	Description	Part #
-	BLADE ASSEMBLY, SCRAPER	005100
1	BLADE, SCRAPER, NYLON	005098
2	HOLDER, BLADE ASSEMBLY	123270
3	CLIP, SCRAPER LOCKING	N59854
4	CLIP, HAIRPIN RETAINING	003652

Parts List

Description	Part #
SWITCH ASSEMBLY AGITATOR	128485
SWITCH ASSEMBLY SPEED CONTROL	115341
SWITCH ASSEMBLY EMERGENCY STOP	115342
ENCLOSURE NEMA	128458
ENCLOSURE, 12" X 16" X 8"	128460
INVERTER 230 VAC	120436
INVERTER 380/460V	128975
TERMINAL BLOCK 3 - POLE	003888
CONTACTOR 12AMP 4 POLE	111072
FUSE BLOCK	096809
FUSE 20 AMP	071489
TRANSFORMER, 100 VA	115356
LUG, GROUND 14-6 AWG	119829
WIRING KIT, VARIABLE SPEED	132383
RELAY, CONTROL	115358
SOCKET RELAY	115359
WIRING SCHEMATIC VARIABLE	128491
WIRING HARNESS	128482
WIRING HARNESS CONTROL BOX	128483
WIRING HARNESS CONTROL BOX TO AGITATOR	128484
FUSE BLOCK (TYPE M) 3 POLE	120706
COVER AGITATOR TILT	006972
SWITCH LIMIT	081019
MOUNTING TILT SWITCH BRACKET	137966
LATCH	009188
HANDLE & LATCH	044115
HANDLE & SPRING	009180
HANDLE 3/8" X 1" X 12"	001931
HANDLE & BRACKET	009238
KNOB RED BALL HANDLE	012691
RING TOLERANCE	012692
SHAFT DRIVE INA TYPE	116168
SHIELD DRIP	026709
POST PIVOT ASSY	040193
POWER-AID ASSY	040196
AGITATOR ASSY 40GAL	043540
AGITATOR ASSEMBLY 60 GAL	040207
AGITATOR ASSY 80GAL	026684
YOKE BLADE	004923
SCRAPER BLADE ASSY	005100
PIN AGITATOR BLADE	003652
CLIP SCRAPER LOCKING	003655

Description	Part #
BLADE SCRAPER	005098
HOLDER SCRAPER BLADE	123270
SPACER D/INA/2 MOTOR	003727
PLATE BRIDGE	040180
PLATE PIVOT	040181
BREAKER BAR FOR D/INA	073487
DRIVE 208/360V 1.5HP	141902
DRIVE 1.5 HP 240/480V	141901
DRIVE 2 HP 240/480V	128972
DRIVE,2HP 360VOLT	115303B
CONTROL MOUNTING BRACKET	128490
CONTROL MOUNTING	176702
CONNECTOR STRAIGHT	001674
CONNECTOR	N58643
BRACKET, ENCLOSURE MOUNTING	128515
MOUNTING PLATE	128519
MOUNTING BRACKET ASSEMBLY	128516
RING BASIC EXTERNAL	006792
LIMIT SWITCH	081019
LATCH	009188
HANDLE & LATCH SUB-ASSY	016101
HANDLE & BRACKET ASSY	009185
HANDLE & SPRING ROD ASSY	009181
HANDLE 3/8" X 1" X 21"	001932
KNOB RED BALL HANDLE	012961
TING TOLLERENCE	012962
BEARING CYLINDRICAL	009236
SPRING .162" WIRE X .098" OD X3"	009237
PLUNGER/SPRING	MS17005
INSERT HANDLE & LATCH ASSY	016219
COVER HANDLE & LATCH ASSY	016220
MOUNTING PLATE	016221
MOUNT ARM ANGLE 3" X 3" X3"	016223
SHAFT DRIVE 'INA' TYPE	116168
SHIELD DRIP	026709
POST PIVOT ASSY	176714
POWER AID ASSY	040196
COUPLING AGITATOR	003883
BREAKER BAR 3/16" X2 1/2 " X 2 1/2 " X 30"	073487
BAR MOUNTING DRIVE	N56890

Electrical Schematic

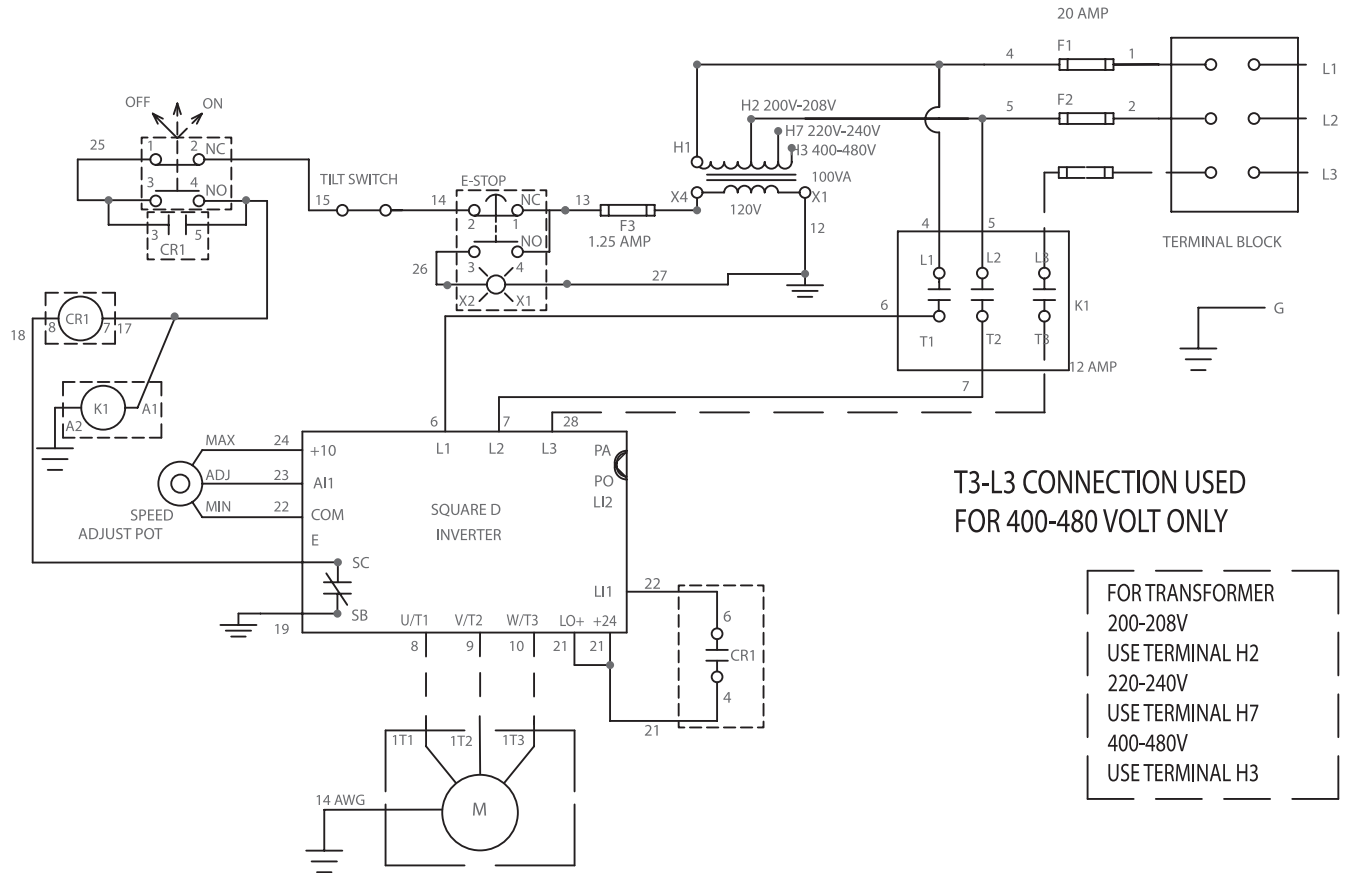

P/N 128491
 REV. D



1055 Mendell Davis Drive • Jackson MS 39272
888-994-7636 • 601-372-3903 • Fax 888-864-7636
unifiedbrands.net