

Progressing cavity pumps MX

KNOLL
.It works

Issue 03-2016



Content

KNOLL .It works	4
Modular system	6
Advantages, features, design features, branches, type code	8
Application examples	10
Suction version	12
Follower plate version	13
Submerged version	14
Hopper version	15
Pump series.	16
Options and certificates	18
Checklist	19

KNOLL .It works

KNOLL's approximately 950 employees make it the largest employer in the Upper Swabian district of Bad Saulgau in Germany. The family-owned business supplies conveyors, filter systems and pumps to manufacturers and users of machine tools throughout the world. The company has grown continuously on its own premises since 1974. Its affiliation with and sense of responsibility towards the local area are a key part of its corporate philosophy. The fully-certified progressing cavity pump MX meets the specific and stringent requirements of the food, pharmaceutical and cosmetics industries. The MX exhibits outstanding stability under pressure and is easy to clean. These facts combined with the excellent service means that the MX can be put to a variety of uses in the chemical, painting, coating and paper industries.







Discharge nozzle DIN32676



Stator EW40/10



Suction housing DIN32676



Discharge nozzle tangential outlet

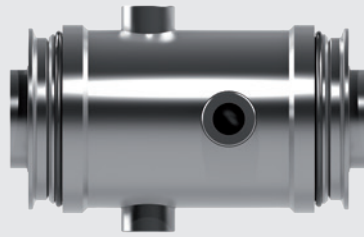

Stator EW25/10 with double jacket

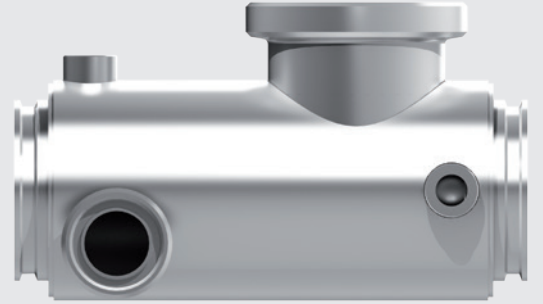

Hopper housing with CIP nozzle and double jacket



Discharge nozzle DIN11851

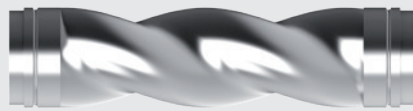

Stator EW30/10



Suction housing DIN11851



Discharge nozzle EN1092-1



Stator EW15/40

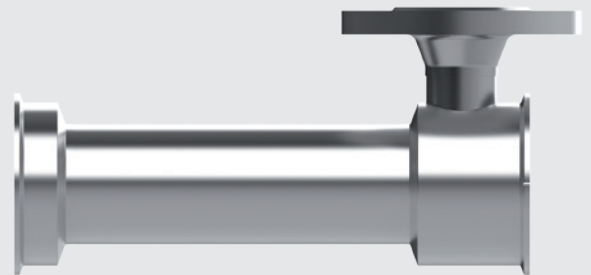

Suction housing EN1092-1



Discharge nozzle DIN11864-1



Stator EW20/20



Rectangular hopper housing with two CIP nozzles

Modular design

The modular design of the MX makes it suitable for numerous applications and extremely easy to maintain. The wide variety of components enable the pump to be modified in the optimum way to suit customers' specific applications.



Hygienic mechanical seal MXHS

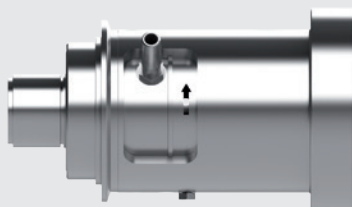

Double acting mechanical seal for quench MXHS-MXEB



Elastomer bellow mechanical seal MXEB

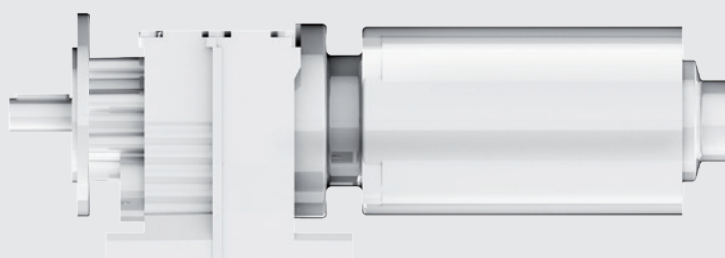

Gear motor in aseptic design

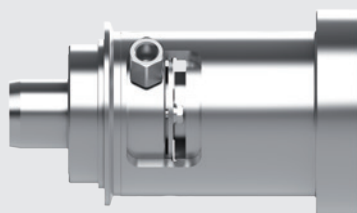

PS shaft seal with flushing

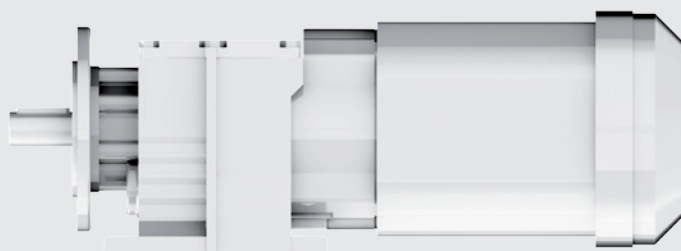

Spur gear motor

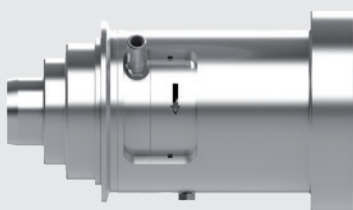

Gland packing with flushing



Servo gear motor

Advantages

1. 10 bar per pressure stage thanks to EvenWall® technology
2. Compact assembly length at high pressures
3. Low-impact product delivery
4. Quick and easy to clean
5. Captive connecting elements
6. Modular design
7. Outstanding stability under pressure

Design features – example MX20S

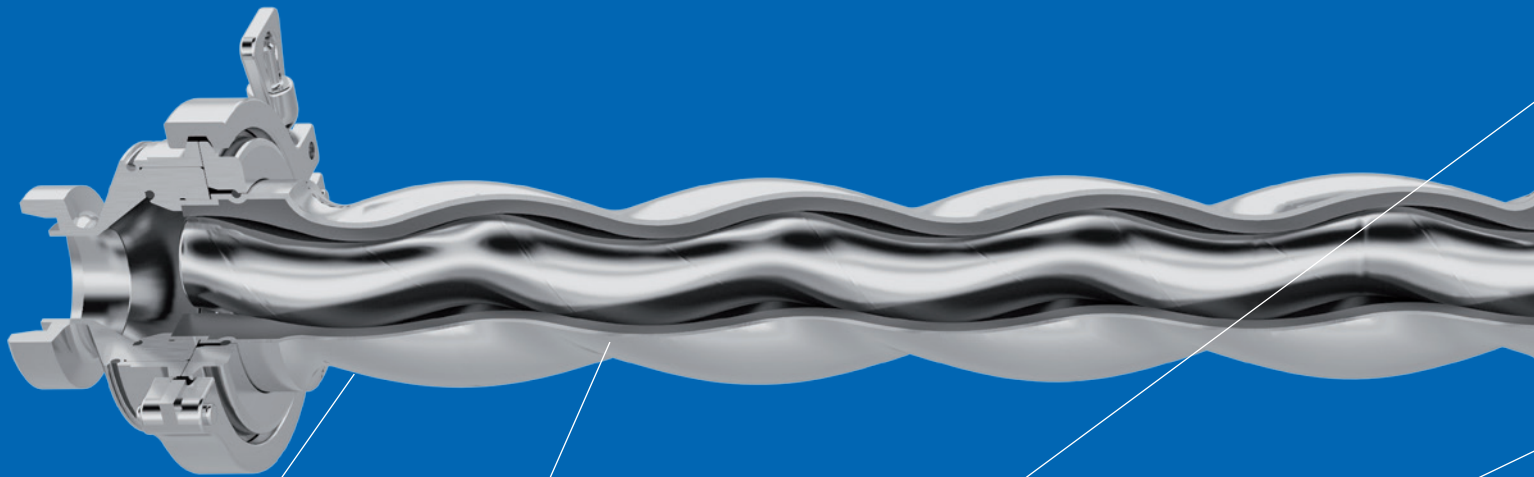

Modular design
(various pump
assemblies can be
adapted)

Stators in
EvenWall®
design (uniform
elastomer wall
thickness)

Fast disassembly
and assembly by
means of clamping
closures

Hygienic sleeve

Cardan joint

Features

- Compatible with CIP and SIP
- Hygienic design
- Design with minimal dead space
- Extremely easy to service
- Intelligent interfaces

The progressing cavity pump MX meets the specific and stringent requirements of the food, pharmaceutical and cosmetics industries. Advanced design features make the pump extremely easy to clean and service, and it comes with all standard certificates. The fact that the MX exhibits outstanding stability under pressure means that it can also be put to a variety of uses in the chemical, painting, coating and paper industries.

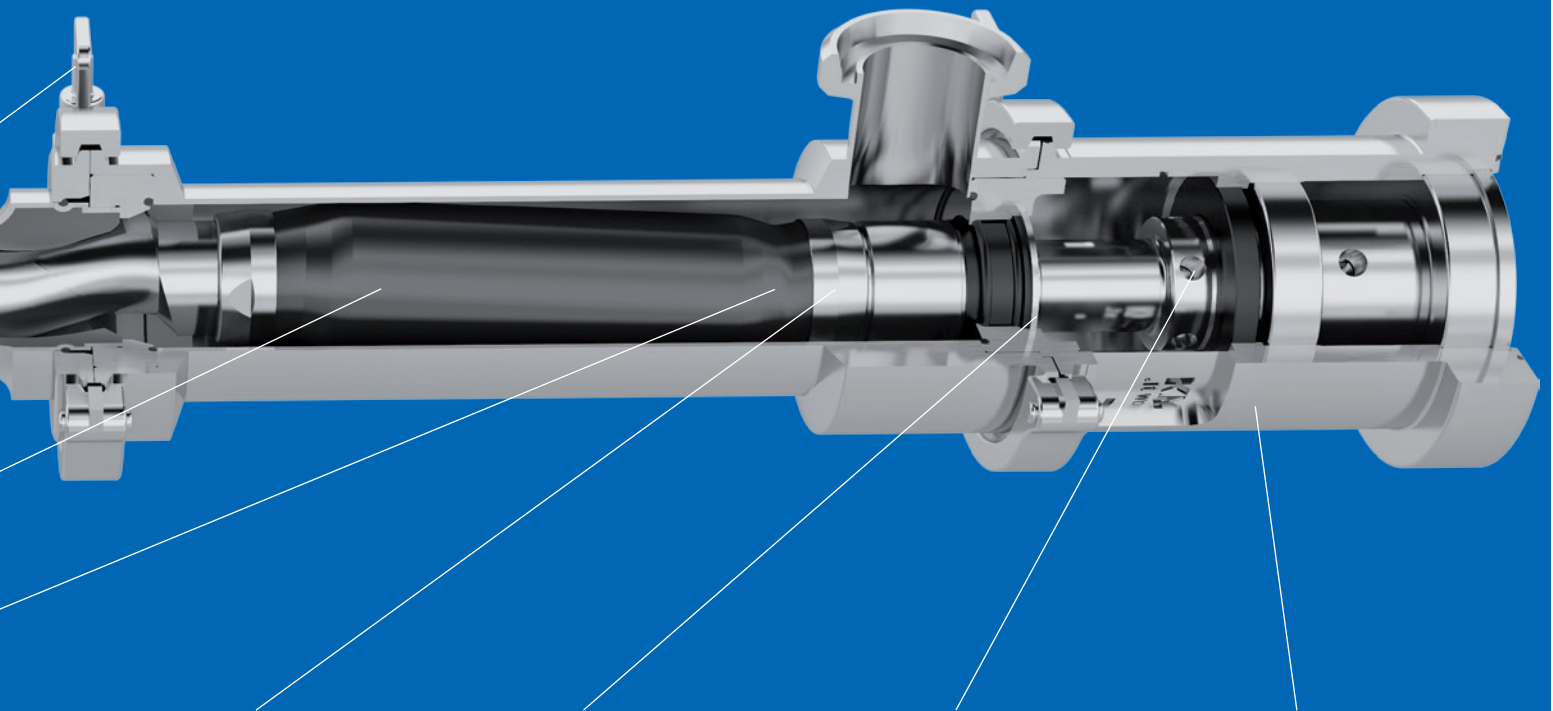

Non-slip cylindrical connection elements prevent the unintentional loosening of pump components

Spacious sealing chamber for all seal assemblies

Wear parts can be replaced quickly via a separation point opposite the product

Robust and splash-resistant bearing housing enables a fully assembled "standby pump" to be fitted even without a drive

Type code

MX 20S-15/20

Designation _____
 Size _____
 Model _____
 Pump assembly size _____
 Pressure stage _____

Size: _____
 Model: _____
 Drive shaft diameter _____
 Suction, submergible, hopper, and follower plate versions _____
 Pump assembly size: Rotor diameter _____
 Pressure stage: 20 = 2-stage (max. 20 bar)

Application examples

Food industry | dairy industry | beverage industry | pharmaceutical industry | cosmetics industry | painting and coating industry | chemical industry



Pet food industry MX20S-15/20

Medium: meat slurry
Flow rate: 78 l/h
Pressure: 10 bar
Viscosity: 1,500 mPas

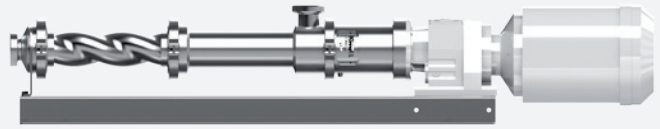

Confectionary industry MX20R-25/10

Medium: fat / fruit puree
Flow rate: 450 l/h
Pressure: 7 bar
Viscosity: 70,000 mPas

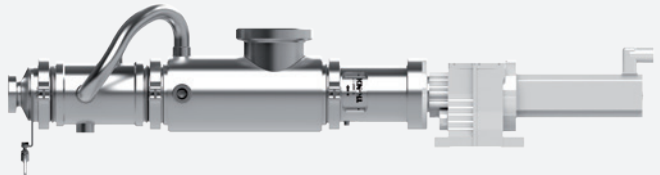

Baked goods industry MX50R-80/10

Medium: dough
Flow rate: 5,800 l/h
Pressure: 6 bar
Viscosity: 12,000 mPas



Food industry | dairy industry | beverage industry | pharmaceutical industry | cosmetics industry | painting and coating industry | chemical industry

Application examples

Food industry MX50S-50/40

Medium: dairy products
Flow rate: 300 – 3,000 l/h
Pressure: 30 bar
Viscosity: 1,300 mPas



Automotive industry MX50R-80/20

Medium: 1K pur adhesive
Flow rate: 3,900 l/h
Pressure: 30 bar
Viscosity: 1,500,000 mPas
Special feature: solid stator made from tool steel



Chemical industry MX20S-25/10

Medium: cleanser
Flow rate: 200 – 800 l/h
Pressure: 0.5 bar
Viscosity: 1 mPas



Types
MX10S
MX20S
MX30S
MX50S



Application

- Metering and transferring applications
- Suitable for aqueous to highly viscous media
- Low-impact delivery of products containing solids

Features

- Vertical and horizontal configuration possible
- Can be used regardless of the direction of rotation
- Self-priming pump to 0.2 bar absolute
- Available as a mobile or stationary pump
- CIP and SIP cleaning possible
- Ability to control the temperature of the entire pump
- Short assembly length

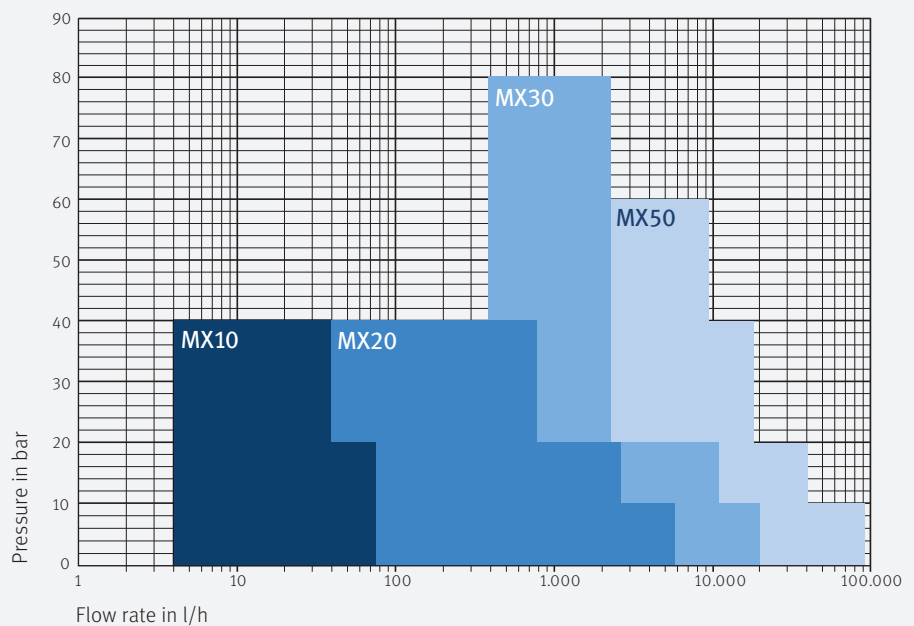

Information based on a medium with a viscosity of 1 mPas and a density of 1.0 kg/dm³

Types
MX10F
MX20F
MX30F
MX50F

Application

- Drum and hopper drained via follower plate
- Low-impact delivery of products containing solids

Features

- Self-priming pump to 0.2 bar absolute
- Short assembly length
- Uniform metering with low pulsation

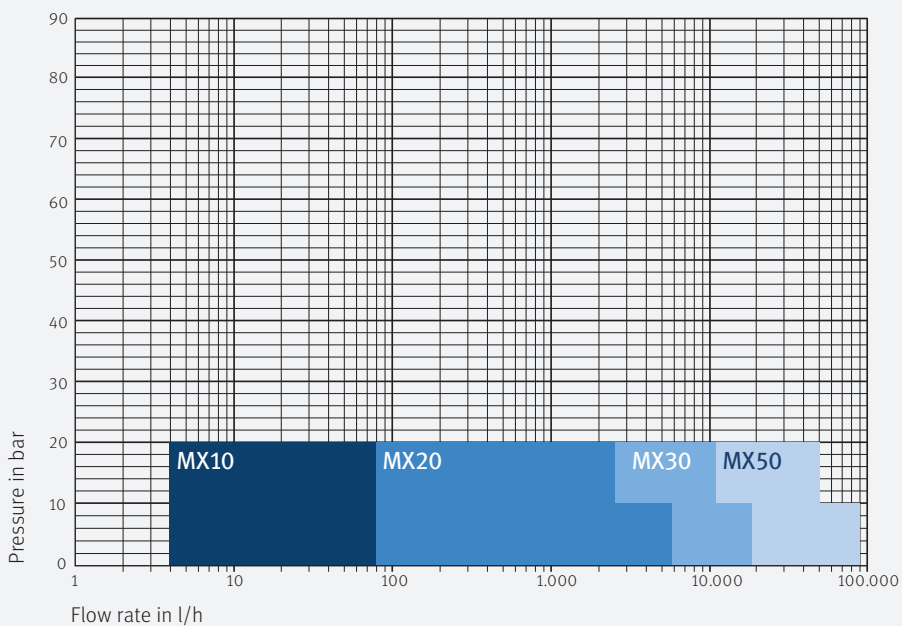

Information based on a medium with a viscosity of 1 mPas and a density of 1.0 kg/dm³



Types
MX20T
MX30T



Application

- Metering and transferring applications
- Suitable for aqueous to highly viscous media
- Low-impact delivery of products containing solids

Features

- Easy to drain drums, mixers, agitators and big bags
- Short assembly length
- Cassette design with minimal dead space
- Uniform metering with low pulsation
- Quick and easy to clean

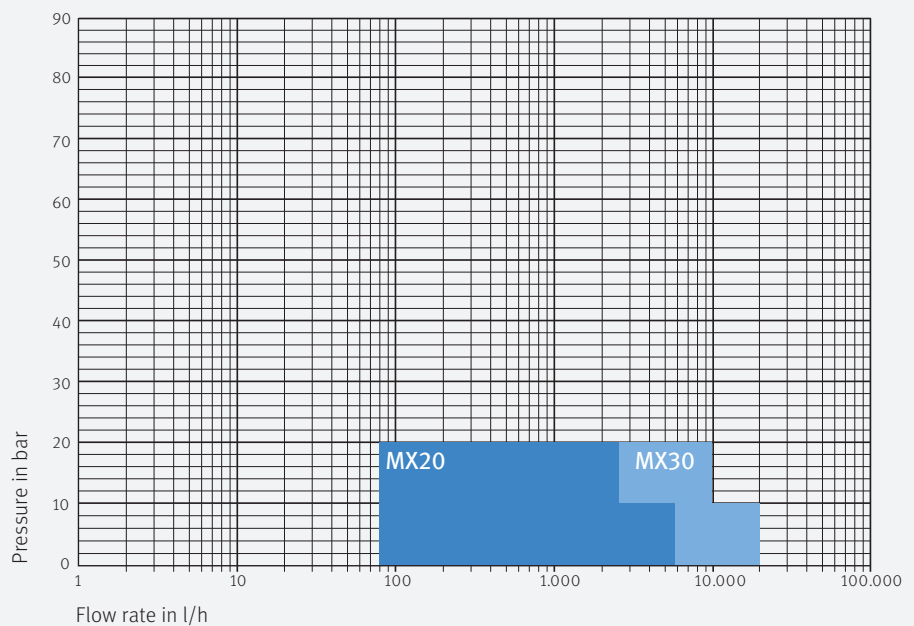

Information based on a medium with a viscosity of 1 mPas and a density of 1.0 kg/dm³

Types
MX20R
MX30R
MX50R

Hopper version

Application

- Highly viscous to airtight media
- Suitable for media with a high solids content
- Metering and transferring applications

Features

- Conical screw conveyor ensures optimum emptying of the hopper floor
- Position of the mechanical seal ensures excellent cleanability
- Well-designed separation points for easy disassembly
- Trough shape prevents deposits from forming on the hopper walls
- Additional extension hopper can be adapted
- Reliable delivery of the medium to the pump assembly thanks to stable screw conveyor shortly before the pump assembly
- Overfeeding in the pump tunnel ensures efficient conveying

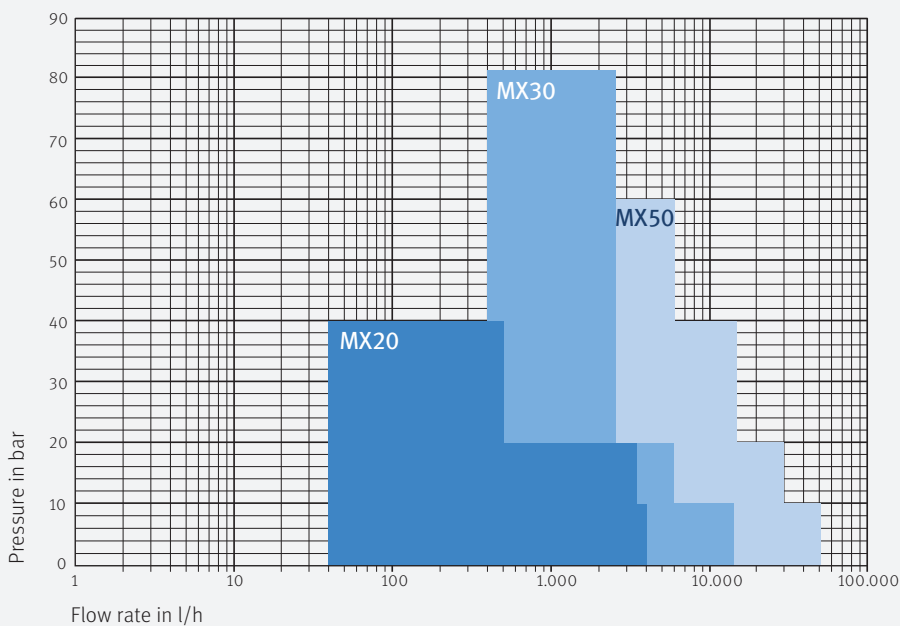

Information based on a medium with a viscosity of 1 mPas and a density of 1.0 kg/dm³

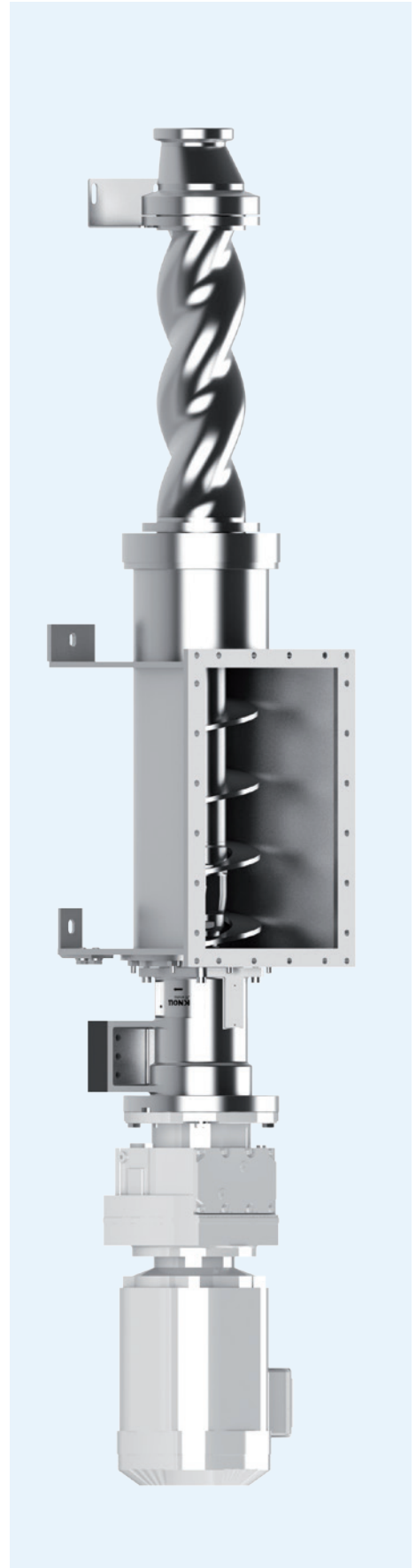

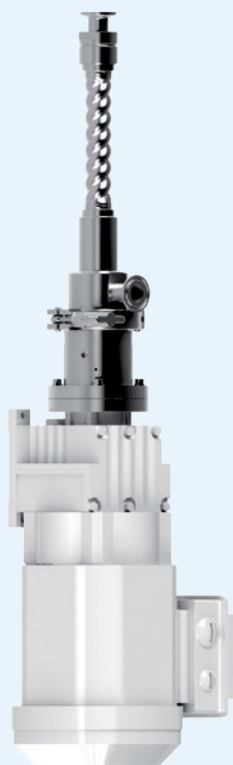

MX10 S; F

Max. pressure:	40 bar
Flow rate:	1 up to 75 l/h
Viscosity:	up to 200,000 mPas
Temperature:	-30 °C up to 140 °C
Solids passage:	up to 6 mm

Available pump assemblies

- 8/40
- 10/20



MX20 S; R; F; T

Max. pressure:	40 bar
Flow rate:	5 up to 5,600 l/h
Viscosity:	up to 200,000 mPas
Temperature:	-30 °C up to 140 °C
Solids passage:	up to 22 mm

Available pump assemblies

- 15/20
- 15/40
- 20/20
- 20/40
- 25/10
- 25/20
- 30/10
- 30/20
- 40/10

MX30 S; R; F; T

Max. pressure:	80 bar
Flow rate:	50 up to 20,000 l/h
Viscosity:	up to 200,000 mPas
Temperature:	-30 °C up to 140 °C
Solids passage:	up to 48 mm

Available pump assemblies

- 30/80
- 50/10
- 50/20
- 60/10



MX50 S; R; F

Max. pressure:	60 bar
Flow rate:	500 up to 100,000 l/h
Viscosity:	up to 200,000 mPas
Temperature:	-30 °C up to 140 °C
Solids passage:	up to 76 mm

Available pump assemblies

- 50/40
- 50/60
- 60/40
- 80/10
- 80/20
- 100/10



Double jacket for tempering

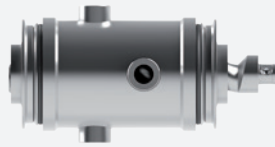

Pump assembly with double jacket



Suction housing with double jacket

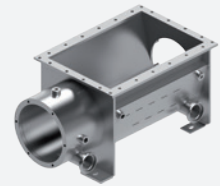

Hopper housing with double jacket

Base plates



Base plate in cap profile



Base plate with height adjustable feet



Hygienic base frame



Mobile base plate

Materials

Materials in contact with the product: 1.4571, 1.4404, 1.4301

Elastomer parts: Elastomers in different qualities, with conformity FDA 21 CFR 177.2600 and EU 1935/2004

Connections: DIN11851, DIN32676, DIN11864-1, DIN11864-2, DIN11864-3, DIN EN1092-1

KNOLL Maschinenbau GmbH is certified in accordance to:

The MX is available in:



Contact details

Company:

Address:

Contact person:

Telephone / E-mail: _____ / _____

Process description

Product specification

Medium:

Flow rate (l/h):

Viscosity (mPas):

Density (kg/dm³):

Temperature (°C):

Concentration (%):

Particle size (mm):

Discharge pressure (bar):

Inlet pressure (bar):

Arrangement:

Regulations:

Cleaning CIP SIP manual

Medium:

Temperature (°C):

Concentration (%):

Comments:

KNOLL
.It works

KNOLL Maschinenbau GmbH
Schwarzachstraße 20
DE-88348 Bad Saulgau
Tel. +49 (0) 75 81/20 08-0
Fax +49 (0) 75 81/20 08-230
info.itworks@knoll-mb.de
www.knoll-mb.de
blog.mx-pumps.com

MX