

NI4-DSU35-2DNETX5-H1150

Inductive Sensor – For Rotary Actuators

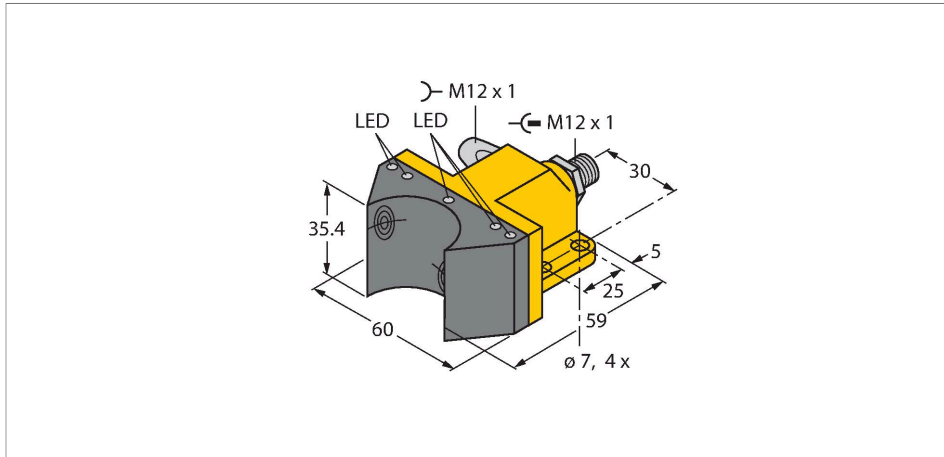

Features

- Rectangular, housing DSU35
- Plastic, PP-GF30-VO
- Two outputs for monitoring the position of rotary actuators
- Direct connection to DeviceNet™ networks
- Valves can be connected
- DC 5-wire, 11...25 VDC
- M12 x 1 male connector

Wiring diagram

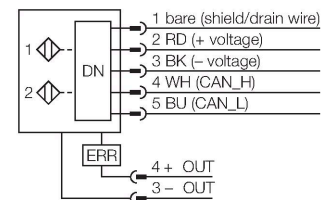

Technical data

Type	NI4-DSU35-2DNETX5-H1150
ID no.	1569908
Rated switching distance	4 mm
Mounting conditions	Non-flush
Correction factors	St37 = 1; Al = 0.3; stainless steel = 0.7; Ms = 0.4
Repeat accuracy	≤ 2 % of full scale
Temperature drift	≤ ± 10 %
Hysteresis	3...15 %
Ambient temperature	-25...+70 °C
Operating voltage	11...25 VDC
No-load current	≤ 60 mA
Isolation test voltage	≤ 0.5 kV
Communication protocol	DeviceNet
Output function	5-wire, 2 normally open contact
Address (MacID)	0 - 63, via EDS file
Baud rate	via EDS file
DeviceNet input data	Bit 0 S01 input / Bit 1 S02 input / Bit 2 output error / Bit 7 input error
	Bit 3 - Bit 6, not used
DeviceNet output data	Bit 0 valve output
	Bit 1 - Bit 7, not used
Output voltage	U _B - 3 V, PNP
Rotary actuators output current	earthing not permitted
Short-circuit protection / output watchdog	yes / no

Functional principle

Inductive sensors detect metal objects contactless and wear-free. For this, they use a high-frequency electromagnetic AC field that interacts with the target. Inductive sensors generate this field via an RLC circuit with a ferrite coil.

LED	Colour	State	Status
S01	YE	on	target detected
S02	YE	on	target detected
out	YE	off	output off
		on	output on
ERR	RD	on	output on/off: wirebreak detected
status	RD/GN	off	sensor not powered
		GN on steady	sensor active and allocated by a master
		GN flashing	sensor active but not allocated by a master
		RD flashing	recoverable fault (open output, invalid input state, low bus voltage, I/O timeout)
		RD on steady	major fault (duplicate address, baud rate, bus off comm.)
		GN+RD on	autobaud detect
		GN+RD flashing	power-up test

Technical data

Wire breakage protection	≤ 0.1 mA
Switching frequency	0.05 kHz
Design	Dual sensor for valve monitoring, DSU35
Dimensions	59 x 60 x 35.4 mm
Housing material	Plastic, PP-GF30, Yellow
Active area material	Plastic, PP-GF30, black
Max. tightening torque of housing nut	3 Nm
Electrical connection	Connector, M12 × 1
Valve connection	Connector, M12 x 1
Vibration resistance	55 Hz (1 mm)
Shock resistance	30 g (11 ms)
Protection class	IP67
Switching state	2 × LEDs, Yellow/Yellow

Accessories

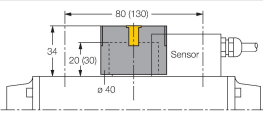
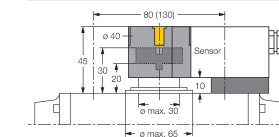
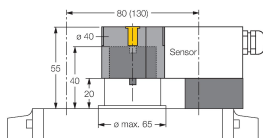
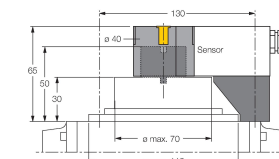
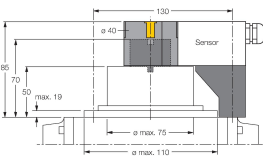
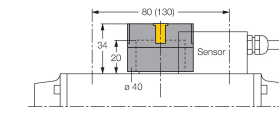
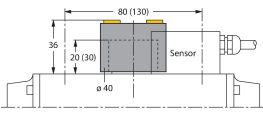
<p>BTS-DSU35-EB1</p> 	<p>6900225</p> <p>Actuation kit (puck) for dual sensors; end position damped; hole pattern on receptacle surface: 80 x 30 mm and 130 x 30 mm; connection shaft (shaft extension) height: 20 mm (30 mm)/Ø: max. 30 mm</p>	<p>BTS-DSU35-Z01</p> 	<p>6900229</p> <p>Mounting kit for dual sensors for larger rotary actuators; Ø spacer plate and snap ring: max. 65 mm; hole pattern on receptacle surface: 30 x 80 mm (30 x 130 mm); connection shaft (shaft extension) height: 20 mm/Ø: max. 30 mm</p>
<p>BTS-DSU35-Z02</p> 	<p>6900230</p> <p>Mounting kit for dual sensors for larger rotary actuators; Ø spacer plate and snap ring: max. 65 mm; hole pattern on receptacle surface: 30 x 80 mm (30 x 130 mm); connection shaft (shaft extension) height: 20 mm (30 mm)/Ø: max. 40 mm</p>	<p>BTS-DSU35-Z03</p> 	<p>6900231</p> <p>Mounting kit for dual sensors for larger rotary actuators; Ø spacer plate and snap ring: max. 110 mm; hole pattern on receptacle surface: 30 x 130 mm; connection shaft (shaft extension) height: 30 mm/Ø: max. 70 mm</p>
<p>BTS-DSU35-Z07</p> 	<p>6900403</p> <p>Mounting kit for dual sensors for larger rotary actuators; Ø spacer plate and snap ring: max. 110 mm; hole pattern on receptacle surface: 30 x 130 mm; connection shaft (shaft extension) height: 50 mm/Ø: max. 75 mm</p>	<p>BTS-DSU35-EBE3</p> 	<p>6901070</p> <p>Actuation kit (puck) for dual sensors; end position damped; "open" and "closed" switchpoint adjustable; hole pattern on receptacle surface: 80 x 30 mm and 130 x 30 mm; connection shaft (shaft extension) height: 20 mm/Ø: max. 30 mm</p>
<p>BTS-DSU35-EU2</p> 	<p>6900455</p> <p>Actuation kit (puck) for dual sensors; end position undamped for clockwise and counter-clockwise drives; hole pattern on flange surface 80 x 30 mm and 130 x 30 mm; connection shaft (shaft stud) height 20 (30) mm / Ø max. 30 mm</p>		